



# Mygo Stander

## User Manual



**The Mygo Stander can be positioned in prone, upright or supine, to allow a progressive and varied standing therapy programme. For use by individual or multiple children, the Mygo Stander aids and increases functionality for children of all abilities. With its intelligent knee supports and dynamic footplates it can bring standing therapy to children with fixed knee contractures of up to 25 degrees.**

---

It is easy and intuitive to use and simplifies the process of getting your child into a comfortable and secure standing position. It's standing made simple, whilst accommodating a broader range of complexities. This manual shows you how you can quickly and easily make use of all of the functions. The instructions on the safety and maintenance of the product will ensure that you will enjoy it for a long time.

# **CONTENTS**

|    |  |
|----|--|
| 01 | Intended use                           |
| 02 | Certification                          |
| 03 | Warning and Cautions                   |
| 04 | Terms of warranty                      |
| 05 | Product history record                 |
| 06 | Product Training                       |
| 07 | Safety Information                     |
| 08 | Precautions and Contraindications      |
| 09 | How to unpack and assemble             |
| 10 | Fitting the covers                     |
| 11 | Clinical setup for postural management |
| 12 | Frequent adjustments for daily use     |
| 13 | Cleaning and care information          |
| 14 | Daily product inspection               |
| 15 | Annual product inspection              |
| 16 | Reissuing Leckey products              |
| 17 | Product servicing                      |
| 18 | Technical information                  |

## SECTION 01: INTENDED USE

### Intended use

The devices are intended to assist children that cannot stand or maintain a standing position independently as part of a supported weight bearing program.

### Indications for use

Mygo Stander is for use in prone, supine and upright standing. Mygo Stander comes in 2 sizes, size 1 is for kids aged 4-10 and size 2 is for 8-14 years, with a maximum user weight of 50kgs (110lbs) and 60kgs (132lbs) respectively. Suitable for:

- Children with disabilities such as Cerebral Palsy, traumatic brain injuries, muscular dystrophy and other conditions where supported standing programs are encouraged.
- Children with fixed knee and hip contractures of up to 25 degrees.

## SECTION 02: CERTIFICATION

The Mygo Stander is classified as a Class I Medical Device under EU and UK regulations. As the manufacturer, James Leckey Design Limited, declares that this product conforms to the Medical Device Regulation (2017/745), UK Medical Device Regulations 2002, Medical Device Directive (93/42 EEC) and EN 12182:2012 Assistive products for persons with disability, general requirements and test methods.

**Notice to the user and/or patient: Any serious incident that has occurred in relation to the device should be reported to the manufacturer and the competent authority of the Member State in which the user and/or patient is established.**



**NOTE:**

**General user advice.**

Not following these instructions may result in physical injury, damage to the product or damage to the environment!

---

## **SECTION 03: WARNINGS AND CAUTIONS**

### **1) WARNING TOPPLING HAZARD**

- Never use the product on a sloping surface greater than 5 degrees.
- Always check operation of linear drives, gas struts, and motor drives before use.
- When adjusting the stander angle ensure there is adequate access space on all sides of the product.
- Always lock casters facing outwards before placing the user in the product.

### **2) WARNING FINGER TRAP HAZARD**

- Ensure that the user or carer does not touch any moving joint or pivot that is not locked.
- While the user is in the product, the carer should strive to keep product adjustments to a minimum.

### **3) WARNING OCCUPANT SECURITY**

- User transfers in and out of the product must be done with appropriate equipment and personnel.
- When transferring the user into the product, first use the pelvic band to secure the user.
- Ensure that all harnesses, sandal straps and chest pad are securely applied.
- If the user exhibits any form of distress, remove from the product as quickly as is safely possible.

### **4) CAUTION FINGER PINCH HAZARD**

- While the user is in the product, the carer should strive to keep product adjustments to a minimum.
- Take care when assembling or adjusting the position of the stander components that your fingers do not get pinched when positioning stander components and tightening mountings.
- During product assembly and adjustment, the carer should avoid finger pinching risk of the product's joints or pivots.
- During transfers and adjustments, the carer should avoid the finger pinching risk of over-centre buckles and latches.

### **5) CAUTION DAILY CHECKS**

- The stander is to be checked daily before use to ensure that all harnesses and stander components are securely attached.
- Always check operation of linear drives, gas struts, and motor drives before use.

### **6) CAUTION TRIP HAZARD WITH POWERED CHASSIS**

- Before moving a powered stander ensure that battery charging connection is removed.

## **7) CAUTION CLEANING**

- Clean the stander regularly to prevent the build-up of dirt. Accumulated dirt can prematurely wear the fabric components and encourage corrosion on the stander. Only use non-abrasive household cleaners and moist cloths, do not use running water on the upholstery whilst it is still attached to the seat. See section Cleaning and care information.

## **8) CAUTION CLEANING POWER WASHERS/HOSES**

- Hoses and power washers are not to be used to clean the product. Stander with the electric lift system are not sealed against running water and may be damaged by water ingress. See section Cleaning and care information.

## **9) CAUTION SERVICING/REPAIR OF ELECTRONIC COMPONENTS**

- All electronic and electrical components are NOT user-serviceable. Servicing and repairs are only to be carried out by Leckey-authorized personnel.

## **10) CAUTION DISPOSAL**

- When disposing of the product using a community waste disposal site, the frame and any electrical components should be disposed of separately.

## **11) CAUTION BRINGING INTO USE**

- Before use, allow 2 hours for the product to acclimatise to room temperature.

## **SECTION 04: TERMS OF WARRANTY**

The warranty applies only when the product is used according to the specified conditions and for the intended purposes, following all manufacturers' recommendations (also see general terms of sale, delivery and payment). A three year warranty is provided on all Leckey manufactured products and components.

## **SECTION 05: PRODUCT HISTORY RECORD**

Your Leckey product is classified as a Class 1 Medical device and as such should only be prescribed, set up or reissued for use by a technically competent person who has been trained in the use of this product. Leckey recommend that a written record is maintained to provide details of all setups, reissue inspections and annual inspections of this product.

## **SECTION 06: PRODUCT TRAINING RECORD**

Your Leckey product is a prescribed Class 1 Medical Device and as such Leckey recommend that parents, teachers and carers using the equipment should be made aware of the following sections of this user manual by a technically competent person.

### **SECTION 07**

Safety Information

### **SECTION 12**

Frequent Adjustments for Daily Use

### **SECTION 13**

Cleaning and Care Information

### **SECTION 14**

Daily Product Inspection

Leckey recommend that a written record is maintained of all those who have been trained in the correct use of this product.

## **SECTION 07: SAFETY INFORMATION**

1. Always read instructions fully before use.
2. Users should not be left unattended at any time whilst using Leckey equipment.
3. Only use Leckey approved components with your product. Never modify the product in any way. Failure to follow instructions may put the user or carer at risk and will invalidate the warranty on the product.
4. If in any doubt as to the continued safe use of your product or if any parts should fail, please cease using the product and contact our customer services department or local dealer as soon as possible.
5. Carry out all positional adjustments and ensure that they are securely fastened before you put the user into this product. Some adjustments may require the use of a tool which is provided with each product. Keep all tools out of reach of children.
6. When placing the user into the standing frame, for safety reasons, always secure the pelvic band first. The chest and knee straps should then be fastened.

7. When used in the supine position it is important to ensure the knee pads are fastened securely. Always check the clips are fully engaged.
8. Although the stander is fitted with castors it is not a mobility device. Always ensure that the castor brakes are locked at all times when the frame is in use, being adjusted or even just stored.
9. When adjusting the angle of the Leckey Mygo Stander ensure that the user and all parts of the product are well clear of surrounding furnishings to avoid potential collisions.
10. Fine positional adjustments may be carried out safely when the user is in the product. But it is important to support all pads when adjusting them while the user is in the product.
11. Never leave the product on a sloping surface greater than 5 degrees. Always remember to lock all the castors.
12. The product contains components which could present a choking hazard to small children. Always check that locking knobs and bolts within the child's reach are tightened and secure at all times.
13. Leckey products comply with fire safety regulations in accordance with EN12182. However the product contains plastic components and therefore should be kept away from all direct sources of heat including naked flames, cigarettes, electric and gas heaters.
14. Never place hot items on the Activity Tray as they may damage the plastic.
15. Clean the product regularly. Do not use abrasive cleaners. Carry out maintenance checks on a regular basis to ensure your product is in good working condition.
16. The product is designed for indoor use and when not in use should be stored in a dry place that is not subjected to extremes of temperature. The safe operating temperature range of the product is +5° to +40° Celsius.



## SECTION 08: PRECAUTIONS AND CONTRAINDICATIONS

### Precautions

- Fixed spinal deformities such as scoliosis or kyphosis
- Severe muscle contractures
- Severe muscular or skeletal asymmetry including hip dislocation
- Progressive and muscle wasting conditions
- High risk or recent history of bone fractures
- High risk of pressure related injury or open sores
- Strong, uncontrolled movement patterns
- Poorly controlled seizure activity
- Children dependent on the use of percutaneous endoscopic gastrostomy
- Medical instability including compromised respiratory or cardiovascular function
- Dependant on 3rd party life-sustaining apparatus such as oxygen tanks
- Significant learning disabilities and/or behavioural issues

### Contraindications

- Children experiencing pain or discomfort that cannot be resolved by adjustment of support/positioning
- Children with hip/ knee flexion contracture beyond the limits of the stander

All precautions and contraindications are taken at the discretion of the prescribing clinician or parent. Leckey recommends a trained and experienced clinician to be present during all initial assessment, set ups, configurations, and reissues to minimise risk.

## SECTION 09: HOW TO UNPACK AND ASSEMBLE

Your Mygo Stander will arrive flat in a cardboard box. Firstly remove everything from the box and check you have all the parts you have ordered.

To assemble the product with the stander upright, lift it up from the cross bar **A**, place vertical tubes in between the free lugs on the chassis and line up the holes **B** (the groove in the vertical tube should help with the location).

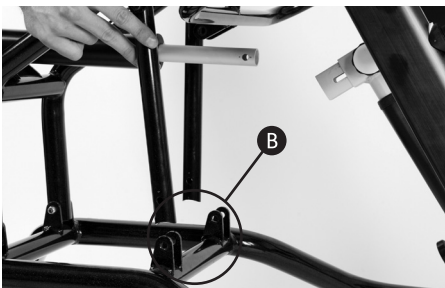

Add the bolts and tighten **C**. Repeat this on the other side. Then lift up the manual actuator to the free lugs on the cross bar and line up the holes, then add bolts and tighten **D**.



## 7.2 HOW TO ATTACH THE CHEST SUPPORT

Remove the screw on the chest support, place the chest support onto the metal extrusion at the required height, replace the screw and tighten.



## 7.1 MULTI TOOL

A number of adjustments will require the use of a multi tool, which is supplied with each product.

## 9.3 HOW TO ATTACH THE TRAY RECEIVER AND TRAY

First of all ensure that your tray is configured to the size of your stander. For the Size 1 the brackets on the tray bars should point outwards **A**. For the Size 2 the brackets on the tray bars should point inwards **B**.

If you need to change the configuration; remove the Allen bolts **C**, swap the bars over **D** then replace the Allen bolts and retighten **E**.

Before inserting the tray receivers the clamp plate for the height adjustment of the tray must be moved out of the way, as it is contained in the top of the hip pad extrusion. To do this; loosen the knob at the top of the hip

pad **F** and push it in, this will push the clamp plate out of the way of the tray receiver bar. Then insert the tray receiver bar into the top of the hip pad extrusion **G**, move it down to the required height and retighten the knob securely.

Repeat on the opposite side. Now you can insert your tray by inserting the tray bars into the receivers to the required depth from the front for prone and the back for supine then retighten securely using knob on receiver **H**.

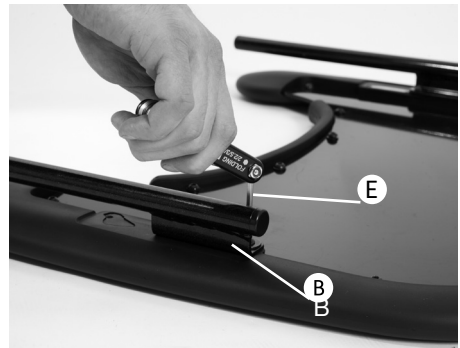

## 9.4 INSERTING ATTACHMENT BOLT ON SANDALS

Insert the required attachment bolt **A** along with the retention plate **B**. Place a rubber lid **C** on both the top and bottom of the sandal. Fasten using the four screws **D** provided. To remove or replace the attachment bolt, reverse this process.

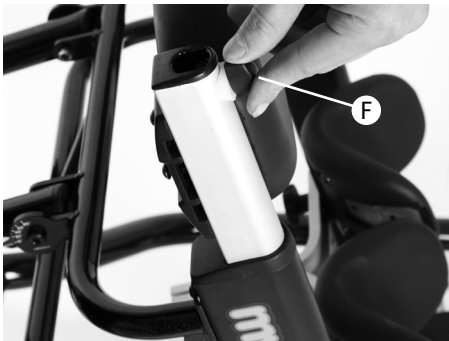
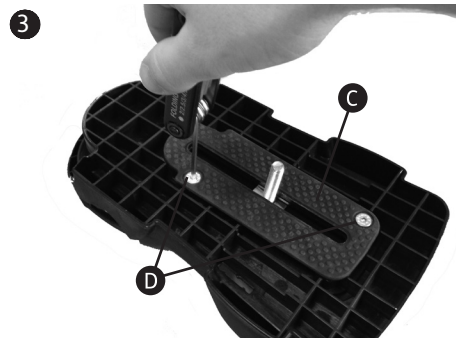
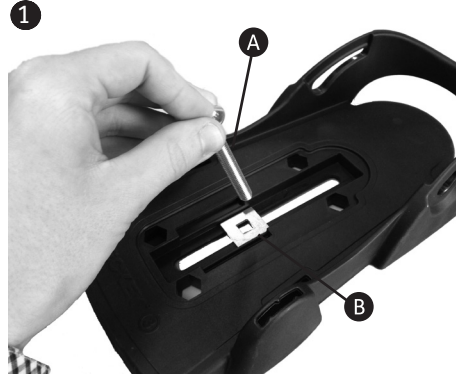

## 9.5 ATTACHING THE SANDALS

Place the sandal so that the attachment bolt goes through the slot in the footplate. To secure, on the underside of the footplate place the rubber washer **A**, followed by the metal washer **B** and then the knob **C** onto the attachment bolt. To position the sandals, simply loosen the knob **C** under the footplate, select the position you require and re-fasten the knob.

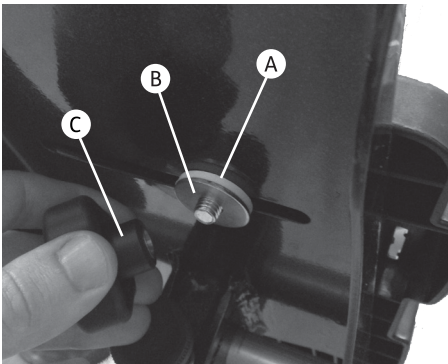

## 9.6 HOW TO ATTACH THE SHOULDER SUPPORT FOR SUPINE STANDING

To attach the shoulder support to the stander, insert the Allen bolt into the bottom hole on the back of the chest support as shown **A**. Place the shoulder support onto the inserted Allen bolt and secure with the two further Allen bolts supplied **B**.

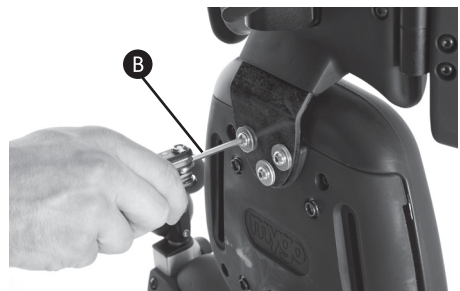
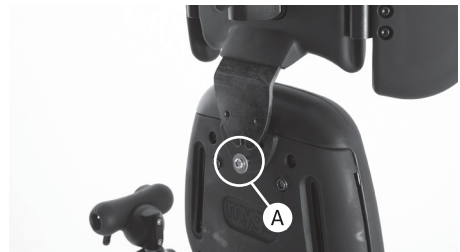

## 9.7 ATTACHING THE HEADREST FOR SUPINE STANDING

The head support cannot be used without the shoulder support for supine standing. To attach the headrest place the headrest clamp onto the shoulder support **A** and secure using the Allen bolts provided. Then slide the headrest stem into the receiving bracket **B**, set the height required and secure using the hand lever **C**.

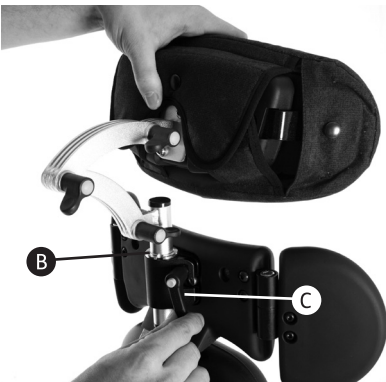

## 9.8 ATTACHING THE KNEE STRAPS

First of all you will need to feed the webbing through the plastic D ring as shown in **A**.

To attach the knee straps insert the plastic clip **B** into the buckle **C** on the side of the main knee support. Then grab the straps ends **D** and pull firmly away from the user, which will secure the strap around the user's leg. To remove the strap, simply squeeze the tabs on the top and bottom of the plastic clip **B** and the strap will pop off.



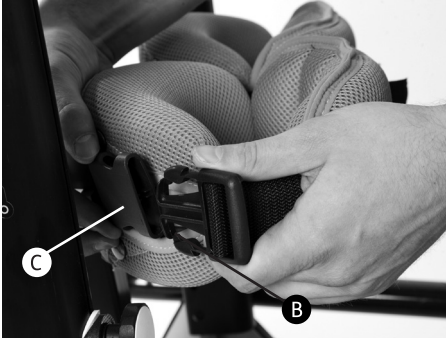

## 9.9 ATTACHING SANDAL RAISERS

If sandal raisers have been ordered, attach them by placing them onto their corresponding building block style recesses on the footplate (a & b). Put the sandal on top and secure with the sandal bolt (as per section 9.4).

## 9.10 ATTACHING THE HIP BELT BRACKET

Before you can attach the de-rotation hip belt you will first of all need to attach the hip belt bracket. To do this slide the bracket into the receiving slots in the hip pad metalwork (A) and secure using the Allen bolt and washer provided (B). Repeat this on the other side. The de-rotation hip belt does not require hip laterals.

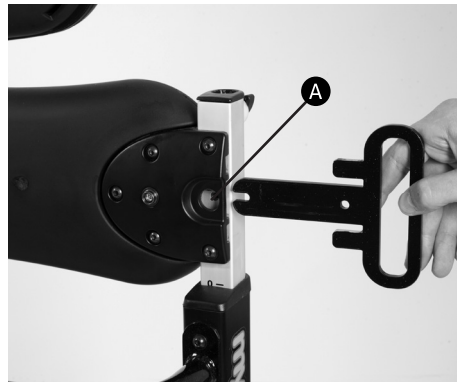



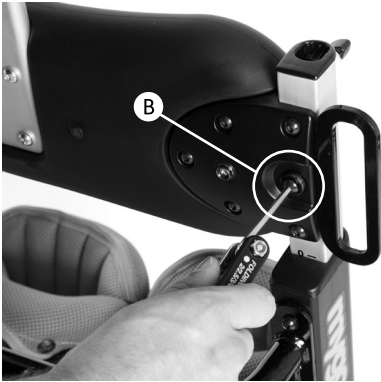

## 9.11 ATTACHING THE HIP LATERALS

The hip wrap around harness requires hip laterals. To attach the hip laterals slide the bracket into the receiving slot in the hip pad metalwork **A** to the required width and secure with the washer and Allen bolt provided **B**. Repeat this on the other side.

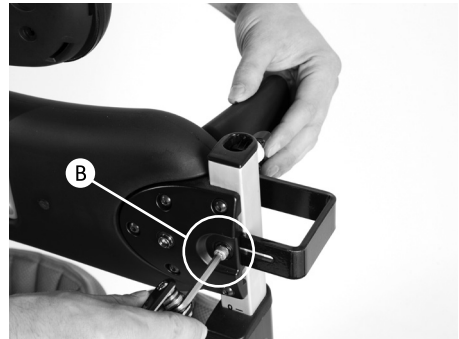

## 9.12 ATTACHING THE POSTERIOR SUPPORT AND POMMEL RECEIVERS

If a posterior support is required, first attach the posterior support receiver by sliding the bracket into the receiving slots in the hip pad metalwork **A** and secure with the washer and allen bolts provided **B**. Repeat this on the other side.





## 9.12.1 ATTACHING THE POMMEL RECEIVER

Attach the pommel receiver **C** to the bracket **D** on the hip pad, using allen bolts provided **E**.

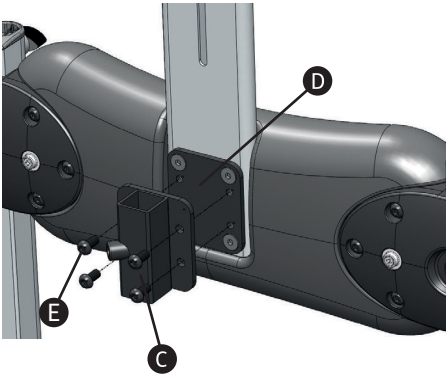

## 9.13 ATTACHING THE STANDARD, FLIPAWAY & COMPLEX CHEST LATERALS

The chest wrap around harness requires chest laterals, either standard or flipaway.

Pull back the PU chest pad to gain access **A**. Then insert the lateral bracket together with the angle adjustment mouldings into the chest pad as shown **B**, ensuring to insert the plastic bosses into the chest pad slot **C**. Then secure from the outside with the Allen bolt and washer supplied **D**. Repeat this on the other side.



## 9.14 ATTACHING THE CHEST/HIP WRAP AROUND HARNESS



To attach the chest/hip wrap around harness, slide the cushions onto the PU lateral with the flaps towards the outside of the stander **A**, feed the plastic buckle **B** through the hole in the cover, then bring the two Velcro fastener straps **C** around the PU lateral and attach them to the Velcro panel as shown. Close over the flap **D**. Repeat this on the other side.

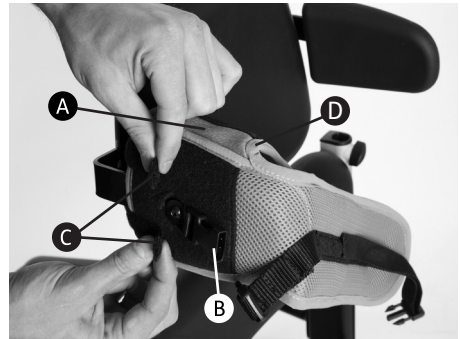
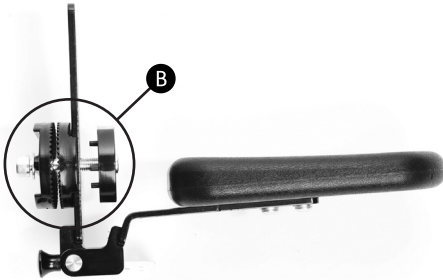

## 9.15 ATTACHING THE PELVIC BAND

There is a different pelvic band for prone and supine standing. In prone the pelvic band should be attached to the user first, if possible on a mat. The inner pelvic band is wrapped around the user's pelvis and then when the user is secured into the frame (by their feet and chest) the longer straps are slipped through the belt bars on the hip pad (A) and secured firmly around the user. The safety strap with

the plastic buckle and clip should then be secured to ensure the band is not accidentally unfastened (B).

In supine the pelvic band should stay attached to the product. When the user is secured into the frame (by their feet and chest) the inner pelvic band is wrapped around the user's pelvis (C) and then the longer straps (D) are slipped through the belt bars on the hip pad (if they are not already through) (E) and secured firmly around the user. The safety strap with the plastic buckle and clip should then be secured to ensure the band is not accidentally unfastened (F).

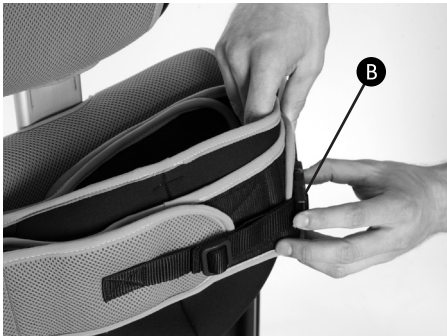
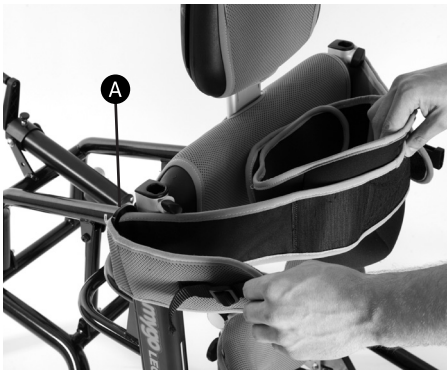

## SECTION 10: FITTING COVERS

### 10.1 KNEE SUPPORT COVERS

Wrap the covers around the knee supports and secure by pressing down on the four snap fasteners. There are two on either side of the knee support **A**. Repeat this on the other knee support.



### 10.2 HIP PAD COVER

Place the cover on the hip pad in the correct orientation. Wrap the bottom flap underneath the hip pad and press down on the snap fasteners to secure **A** then wrap the top flaps of the cover over the top of the hip pad **B**.





## 10.4 SHOULDER SUPPORT PAD

Follow the instructions in section 11.9 to angle the shoulder support laterals inwards, slide the cover over the shoulder wings **A** and secure with the snap fasteners **B**.

## 10.3 CHEST PAD COVER

Wrap the cover over the top of the chest pad and secure by pressing down on the snap fasteners **A**. Then wrap the bottom section underneath and press down on these snap fasteners to secure **B**.

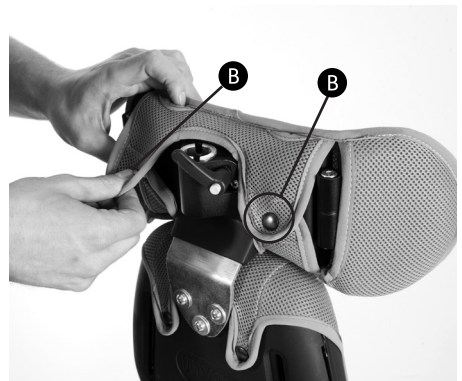
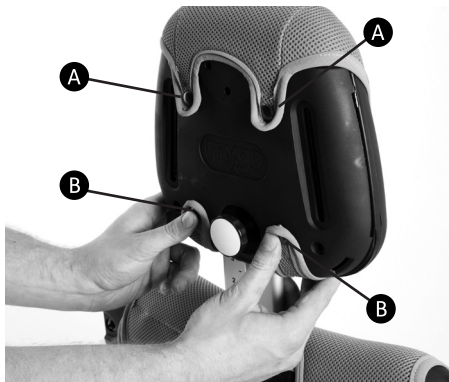

## 10.5 HEAD CUSHION AND COVER

Place the cushion onto the head support. Secure the central fastener **A**. Bring the lower flap under the head support **B** and secure with the two remaining side fasteners **C**.



## SECTION 11: CLINICAL SETUP FOR POSTURAL MANAGEMENT

The clinical setup of the product should be completed by a technically and clinically competent person who has been trained in the use of the product. Leckey recommend a written record is maintained of all clinical setups for this product.

### 11.1 ADJUSTING THE HIP HEIGHT

To adjust the hip height, loosen the knobs on either side of the stander **A**, move the hip pad to the required height and retighten the knobs securely.

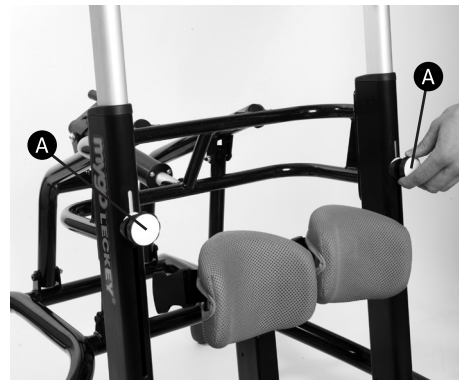

## 11.2 ADJUSTING THE CHEST & SHOULDER SUPPORT HEIGHT

To adjust the chest height and the shoulder support relative to the hip pad, loosen the knob located at the back of the chest support **A**, adjust to the required height and retighten securely.



at the side of the knee post **B**, adjust to the required depth and retighten securely. To alter the lateral position of the knees, loosen the knob at the back of the knee pad **C**, adjust to the required position and retighten securely.

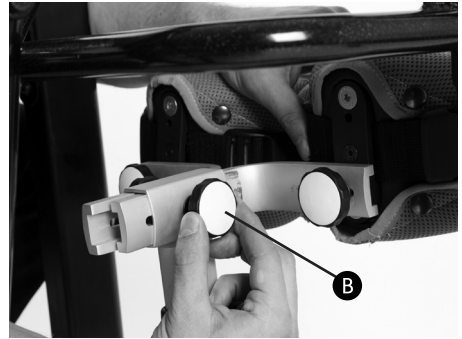
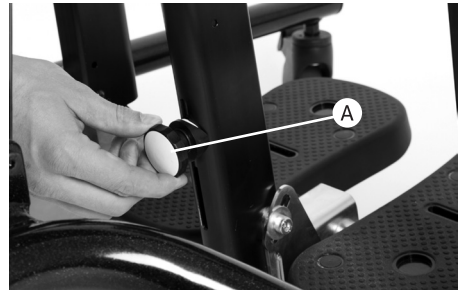

### 11.3.1 ADJUSTING THE KNEE SUPPORTS

The height, depth and lateral position of the knee supports can be positioned independently. To alter the height of the knee supports, loosen the knob located at the back of the knee post **A**, adjust until the required height has been achieved and retighten. To alter the individual depth of the knees, loosen the knob

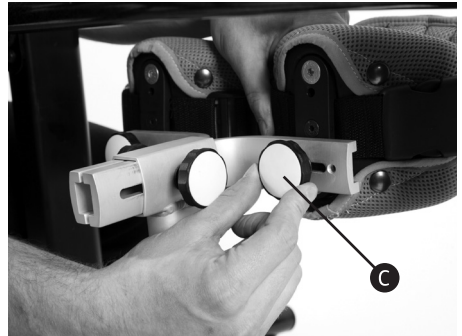



## 11.3.2 ATTACHING THE EXTENDED KNEE BRACKETS

Loosen Knob **C** and remove knee support. Slide extension bracket onto the knee bracket and secure with white rubber washer, silver washer, plastic spacer and knob.

Fix the knee supports to the extension brackets at the required height using black rubber washer, black washer and M6 screw.



## 11.4 ADJUSTMENT TO ACCOMMODATE THE CONTRACTURE ANGLE

If possible, adjustment of the swinging footplate on the Mygo Stander should be performed when the client is out of the stander. However there may be circumstances where it is necessary or preferable to adjust the angle of the swinging footplate with the client in the stander. This process requires two competent persons; one to make the adjustments and one to assess the comfort of the client during the adjustment, and is best performed with the stander in a horizontal position.

### In upright or prone standing:

Assess the client's range of movement, muscle tone, etc, on a plinth and determine the optimum standing posture before positioning the client in the stander. Position the client in the Mygo Stander. While carefully supporting the head and shoulders, move the client into a horizontal position. Open the knee

straps and sandal straps. Loosen the Allen **A** bolt on both sides of the swinging footplate ensuring the weight of the user's knees are supported by a carer, adjust the angle of the swinging footplate as necessary, always taking care to assess the client's comfort, and retighten the bolts securely. Then secure the knee straps and sandal straps. Return the client to prone standing position.

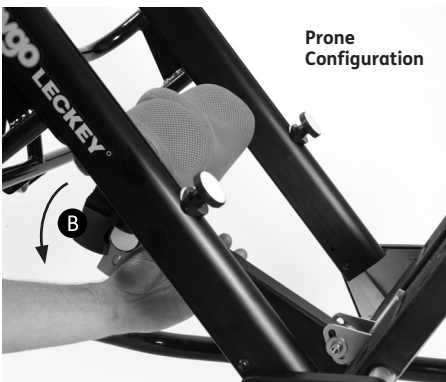

### In supine standing:

Assess the client's range of movement, muscles tone, etc, on a plinth and determine the optimum standing posture before positioning the client in the stander. Position the client in the Mygo Stander and move it into a horizontal position. Open the knee straps and sandal straps. Loosen the Allen bolt **A** on both sides of the swinging footplate ensuring the weight of the user's knees are supported by a carer, adjust the angle of the swinging footplate as necessary, always taking care to assess the client's comfort, and retighten the bolts securely. Then secure the knee straps and sandal straps. Return the stander to preferred supine standing angle.

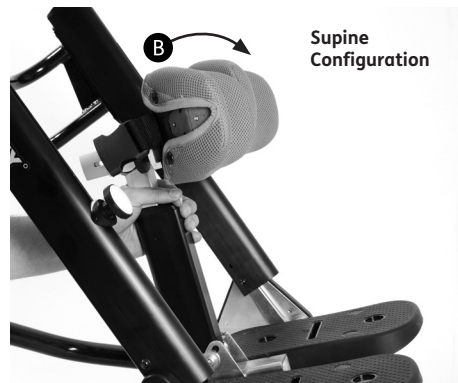

## 11.5 POSITIONING SANDALS

Each sandal is attached to the individual footplate with a single fixing bolt. The footplate is encapsulated in rubber to ensure the sandals do not slide when secured.

To position the user's feet in the sandals secure the Velcro straps provided so the foot is held in place. The straps should be over the bridge of the foot and over the toes. The front strap can be fed through one of two slots on either side of the sandals, depending on the size of the user's feet.



If the child is wearing sandals or light footwear check the straps to make sure the webbing does not irritate the skin.



## 11.6 SECONDARY FOOTPLATE ANGLE

To set the angle to accommodate plantar-flexion or dorsi-flexion, simply loosen the Allen bolt located by the knee post to the inside of the footplate (A), place in the required position and then retighten the bolt securely. 10° of flexion is accommodated in each direction.



## 11.7 ADJUSTING THE HIP LATERALS

To set the width of the hip laterals, loosen the Allen bolts at the back of the hip pad (A), adjust to desired width and retighten.

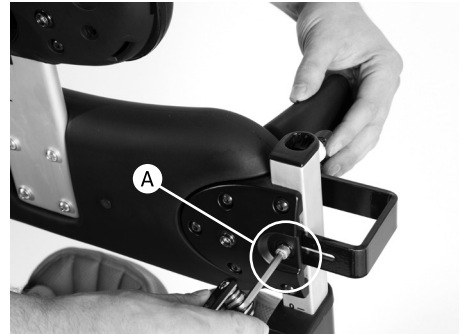

## 11.8 ADJUSTING THE STANDARD, COMPLEX AND FLIPAWAY CHEST LATERAL SUPPORTS

To adjust the height and angle of the lateral supports, loosen the Allen bolt **A**, adjust to the required width, height and angle and retighten securely.



### Complex laterals

The complex laterals can also be angled to allow the pad to contour to the user's shape. To adjust loosen the screw **B** at the centre of the pad, angle the pad to the required position and retighten the screw. The laterals can be flipped away to aid transfer, by pulling the pin **C** at the back and rotating the support out of the way.

## 11.9 SHOULDER SUPPORT

To adjust the angle of the shoulder support laterals, loosen the Allen bolt screw **A**, move laterals to required angle and retighten.



## 11.10 HEADREST

To adjust the height, depth and angle of the headrest, loosen the hand knobs **A** and when set to the desired position retighten the knobs. Do not remove the headrest while the user is in the stander.

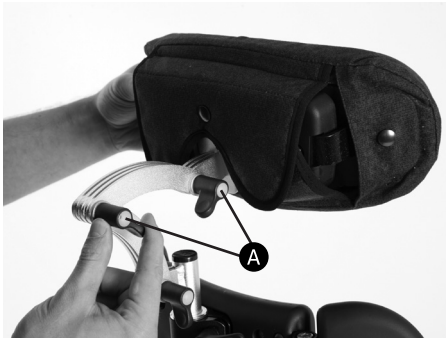

## 11.11 ATTACHING AND ADJUSTING THE POSTERIOR SUPPORT AND POMMEL

To adjust the posterior support, loosen receiver allen bolt **A** slide the outside bars into the receivers **B** to the required depth and tighten **A**.

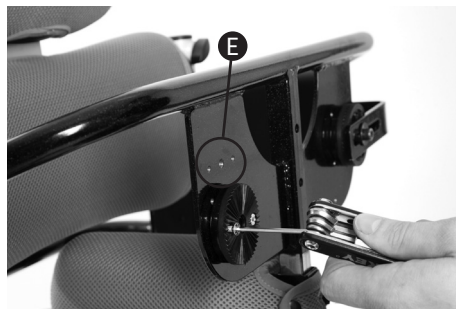
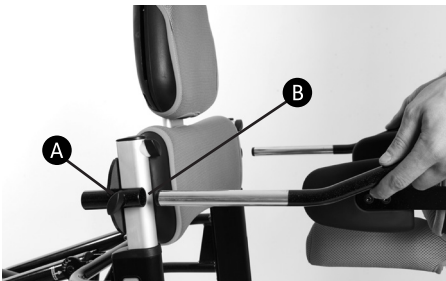

## 911.11.1 ATTACHING AND ADJUSTING THE POMMEL

To attach the pommel, loosen the receiver allen bolt **C**, slide the pommel into the receiver **D** and tighten at the required depth. The height can also be adjusted using the allen bolt **E** at the back of the pommel.

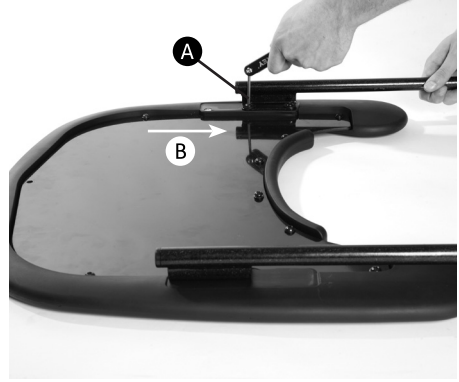
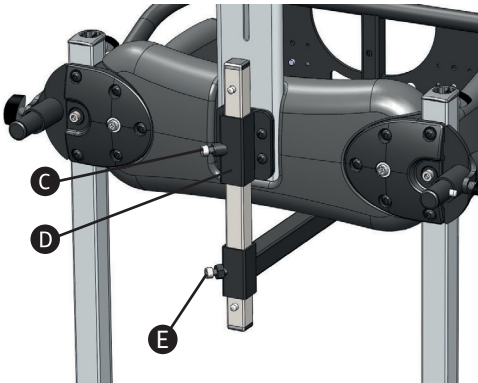

## 11.13 ATTACHING AND ADJUSTING THE TRAY GRAB RAILS

To attach the grab rails firstly remove tray bars. To do this, unscrew the Allen bolts holding the tray bars on **A** (note positioning holes used). Place down spacer plate **B**, then slotted plate **C**. Secure, with tray bar in original holes, using supplied longer screws **D**. Repeat this on the other side.

## 11.12 INCREASE TRAY ADJUSTMENT

To increase the depth adjustment of the tray, reposition the tray bars further back. To do this, unscrew the Allen bolts holding the tray bars on **A**, move the bars to the holes further back **B** replace the bolts and retighten all bolts securely.



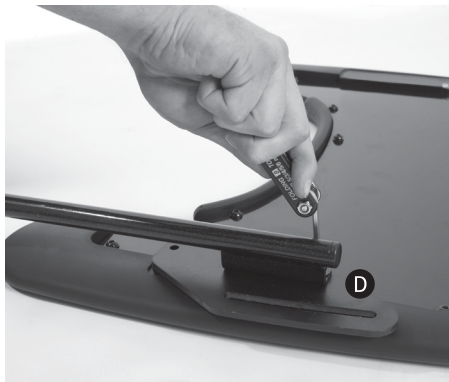
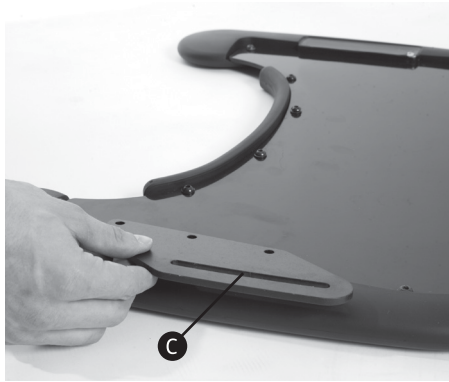
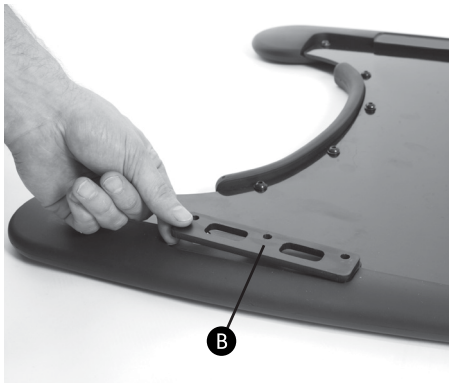

Attach the grab rail receiving brackets **E** as shown. Place the grab rail into the receiving brackets. Adjust to the required height and tighten **F** on both sides.

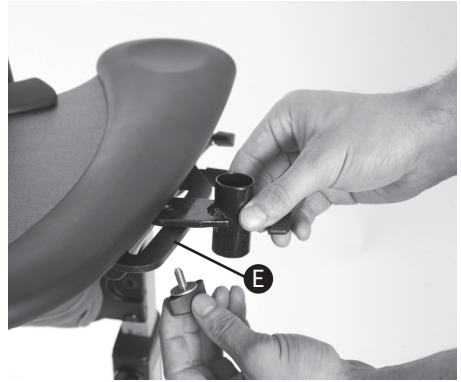

## 11.14 TRAY INSERT CHANGES

To swap out different inserts for tray, firstly, turn the tray upside down, then remove Allen bolts holding in the current insert **A** and tray protection pad (if there is one). Remove old insert **B** and replace with new one and secure to tray and add tray protection pad using same Allen bolts.



## SECTION 12: FREQUENT ADJUSTMENTS FOR DAILY USE

Parents and carers should be shown how to make frequent adjustments and made aware of the safety checks in section 7 by a technically and clinically competent person who has been trained in the use of the product. Leckey recommend that a written record is maintained of all parent and carers who have been trained in the use of this product.

## 12.1 TRANSFERRING THE USER INTO AND OUT OF THE STANDER

Before transferring the child into the stander, carry out the daily product inspection as outlined in section 14 of this user manual. We would recommend that users are never transferred straight from seating to standing without preparation and stretching. This is best done in a lying position whilst on a mat but can be carried out in a wheelchair or seating system if required. Before transferring the child into the product lock all the castors, ensuring that they are facing outwards to maximise product stability. Make sure the straps on the chest harness, pelvic band, knee straps and sandals are released and out of the way to facilitate transfer.



## 12.2 SETTING THE STANDER ANGLE

Whether used in supine or prone the frame angle can be easily adjusted by pulling and twisting the safety lock **A** and turning the handle **B** until the desired angle has been achieved (the angle can be read from the cross bar **C**). Turn the handle clockwise to bring it upright and anti-clockwise to bring it towards horizontal. The stander can adjust from vertical (0°) through to 10° off horizontal (80°). This can be done with the child in the product.



Ensure that the product and user are away from surrounding furnishings to prevent possible collisions when adjusting the angle.

Ensure to lift the safety pin before turning the adjustment handle, to prevent damaging the equipment. The safety pin should be locked and the handle cannot turn before the user is placed into the product.

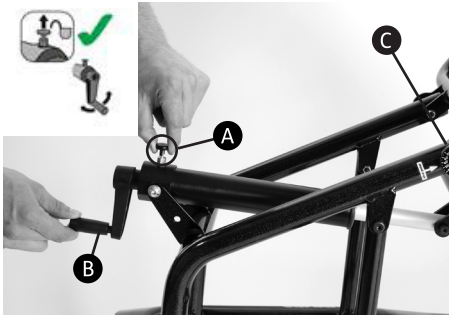

## 12.3 POSITIONING THE SANDALS

To position the user's feet in the sandals, secure the Velcro straps provided so the foot is held in place. The straps should be placed over the bridge of the foot over the toes.

The front strap can be fed through one of two slots on either side of the sandals, depending on the size of the user's feet **2**.



If the child is wearing sandals or light footwear check the straps to make sure the webbing does not irritate the skin.

1



2



## 12.4 KNEE STRAPS

To attach the knee straps insert the plastic clip **A** into the buckle **B** on the side of the main knee support. Then grab the strap ends **C** and pull firmly away from the user, which will secure the strap around the user's leg. To remove the strap, simply squeeze the tabs on the top and bottom of the plastic clip and the strap will pop off.



Always check with your therapist as to the correct tensioning of the straps for your child as the kneecap is a sensitive area and too much force could cause injury.

## 12.5 POSITIONING AND ATTACHING THE PELVIC BAND

There is a different pelvic band for prone and supine standing. In prone the pelvic band should be attached to the user first, if possible on a mat. The inner pelvic band is wrapped around the user's pelvis and then when the user is secured into the frame (by their feet and chest) the longer straps are slipped through the belt bars on the hip pad **A** and secured firmly around the user. The safety strap with the plastic buckle and clip should then be secured to ensure the band is not accidentally unfastened **B**.

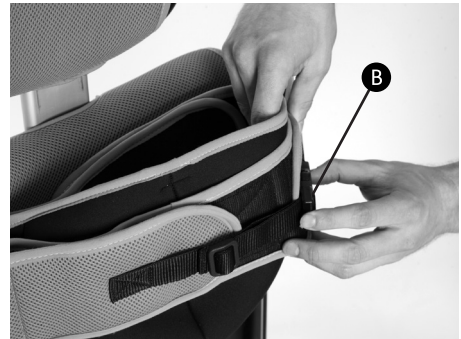
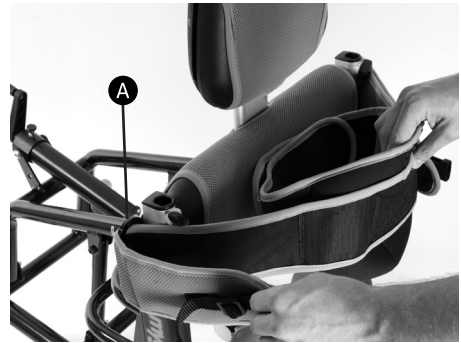
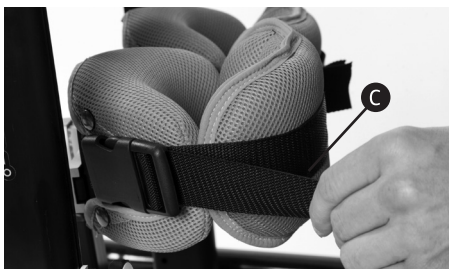
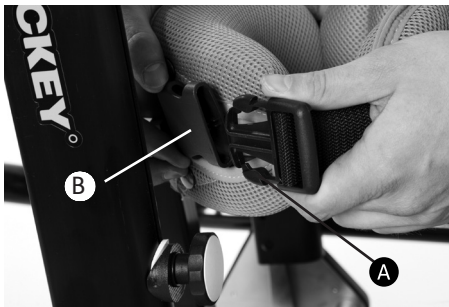

## 12.6 WRAP AROUND LATERAL HARNESS

In supine the pelvic band should stay attached to the product. When the user is secured into the frame (by their feet and chest) the inner pelvic band is wrapped around the user's pelvis **C** and then the longer straps **D** are slipped through the belt bars on the hip pad (if they are not already through) **E** and secured firmly around the user. The safety strap with the plastic buckle and clip should then be secured to ensure the band is not accidentally unfastened **F**.



To open the wrap around chest harness, simply unclip the side buckle **A** and open. Reverse the process when placing the user back in the product, ensuring to secure the straps firmly around the user. The safety strap with the plastic buckle and clip should then be secured to ensure the band is not accidentally unfastened **A**.



Always secure the chest and hip support harnesses (and knees straps when used in supine) first before making other adjustments.

Always make sure the plastic buckles are fully engaged.



## 12.7 TRAY ADJUSTMENT

To insert and adjust the depth of the tray, loosen the knobs on the back of both tray receivers **A**, slide the tray in to the required depth, and retighten. To increase the depth adjustment further, see 9.12.

To adjust the angle of the tray, loosen the plastic handle in the centre of both the tray receivers **B** set the tray to the required angle and tighten the plastic handles again securely.

To adjust the tray height, loosen the knobs at the top of the hip pad **C** adjust receivers to required height and retighten, ensuring the tray is at a level height by matching the scale on the side of the tray receiver bars.

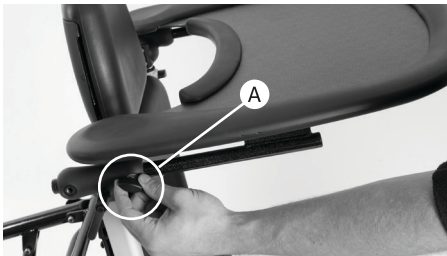

Never use the tray to steer or push the chair.

Do not place hot objects (hotter than 40° Celsius) on the tray.

Please note that the tray is for the use of the user only.

Do not lean or place heavy objects (heavier than 8kgs/17.6lbs) on the tray.



## SECTION 13: CLEANING & CARE INFORMATION

### How to Maintain

When cleaning the product we recommend that you use only warm water and a nonabrasive detergent. Never use organic solvents or dry cleaning fluids.

### Upholstery and fabrics

1. The upholstery and fabrics can be removed and machine washed and tumble dried at a low setting. The standard covers can be washed at 40 degrees Celsius and the Infection Control covers at 90 degrees Celsius. Please remove the foam before washing the head support, posterior support and pommel covers. All other soft upholstery can be placed directly in the washing machine.
2. If the upholstery is to be cleaned in-situ, the best cleaning method is a 'wipe & dry' technique.
3. Staining should be removed as quickly as possible with absorbent cloth, towels or a sponge. Routine soap and warm water sponging is effective for ordinary soiling and minor spills. Be careful not to over

wet the fabric, as this will cause the staining to spread.

4. Antiseptic cleaning agents can be used on more stubborn stains. These may require a safe solvent such as Isopropyl Alcohol or Mineral Spirit. A half cup of household bleach to 5 litres of water can also be used as a useful disinfectant.
5. Always ensure the product is dry before use.

### Metal and plastic components

1. Soap and water or antibacterial spray can be used for daily cleaning.
2. For deep cleaning a low pressure steam cleaner can be used.
3. Do not use solvents to clean plastic or metal components.
4. Make sure the product is dry before use.

## **SECTION 14: DAILY PRODUCT INSPECTION**

### **(Therapists, Parents & Carers)**

We recommend that daily visual checks of the equipment are carried out by therapists, carers or parents to ensure the product is safe for use. The recommend daily checks are detailed below.

1. Ensure all adjustment knobs and bolts are in place and secure.
2. Check all upholstery for signs of wear and tear.
3. Check all wheels are moving freely and lock securely.
4. Check all Velcro strips and brush fluff to ensure straps secure firmly.



If in any doubt to the continued safe use of your Leckey product or if any parts should fail, please cease using the product and contact our customer services department or your local dealer as soon as possible.

## SECTION 15: ANNUAL PRODUCT INSPECTION

### (Therapist, Technician, Leckey Product Advisor, Dealer)

Leckey recommend that each product should be subject to a detailed inspection at least once a year and every time the product is reissued for use. This inspection should be carried out by a technically competent person who has been trained in the use of the product and should include the following checks as a minimum requirement.

1. Check all knobs, nuts, bolts and plastic buckles are in place, replacing any missing items. Pay particular attention to the following items;
  - Buckles and Velcro on pelvic bands, knee straps and wrap around lateral harnesses
  - Hip, knee and chest height adjust and lock securely
  - Contracture angle and secondary footplate angle adjust and lock securely
  - Knee supports depth and width adjust and lock securely
  - Head support locks securely
2. Lift the base to check each wheel individually. Make sure they are moving freely and remove any dirt from the rubber wheels. Check that the brakes lock the wheels securely.
3. Visually check the structure of the product ensuring there are no signs of fatigue or cracking around the welds.
4. Visually check the plastic parts of the product ensuring there are no signs of fatigue or cracking.
5. Leckey recommend that a written record is maintained of all annual product inspections.



If in any doubt to the continued safe use of your Leckey product or if any parts should fail, please cease using the product and contact our customer services department or your local dealer as soon as possible.

## SECTION 16: RE-ISSUING LECKEY PRODUCTS

Most Leckey products are assessed and ordered to meet the needs of an individual user. Before reissuing a product we recommend that the therapist prescribing the product has carried out an equipment compatibility check for the new user and has ensured that the product being re-issued contains no modifications or special attachments.

A detailed technical inspection should be carried on the product prior to re-issuing.

This should be carried out by a technically competent person who has been trained in the use and inspection of the product. Please refer to **section 15** for the required checks to be carried out.

Before re-issuing a product, we recommend it is disinfected using the following procedure:

***Note: Always clean the product first to remove accumulated soiling prior to disinfecting/sanitising***

1. Where possible, we recommend the use of an automated “fogger” disinfection system that is used to completely cover the product surfaces with a disinfectant agent. The manufacturer’s instructions for the chosen system should be referred to prior to use and followed exactly.
2. Where an automated disinfection system is not available, all product surfaces should be wiped over with disinfectant surface wipes or liquid disinfectant on a soft cloth. Suitable products are 70% IPA, 70% Alcohol or diluted bleach. The manufacturer’s instructions for the chosen product should be followed. Product upholstery and fabrics should be cleaned thoroughly in accordance with section, Cleaning and Care Information, of this manual.

Ensure a copy of the user manual is supplied with the product. A copy can be downloaded from our website [www.leckey.com](http://www.leckey.com)

Leckey recommend that a written record is maintained of all product inspections carried out during the reissue of the product.



## **SECTION 17: PRODUCT SERVICING**

Servicing of all Leckey products should only be carried out by technically competent persons who have been trained in the use of the product.

In the UK & ROI please contact the Leckey Service Centre on UK 0800 318265 or ROI 1800 626020 and our customer service department will be delighted to assist you with your servicing requirements.

All international service enquiries should be directed to the appropriate Leckey distributor who will be delighted to assist you. For further information on Leckey distributors please visit our website **[www.leckey.com](http://www.leckey.com)**.













If in any doubt to the continued safe use of your Leckey product or if any parts should fail, please cease using the product and contact our customer services department or your local dealer as soon as possible.







## SECTION 18: TECHNICAL INFORMATION

| Technical Details                                 |                         |                         |
|---|-------------------------|-------------------------|
| Size  | Size 1                  | Size 2                  |
| Age [Years Approx]                                | 4 - 10                  | 8- 14                   |
| Max user weight                                   | 50kgs / 110lbs          | 60kgs / 132lbs          |
| <b>User height</b>                                |                         |                         |
| min   | 1080mm / 42.5 inches    | 1350mm / 53.1inches     |
| max   | 1450mm / 57.1 inches    | 1750mm / 66.9 inches    |
| <b>Chest support height (footplate to armpit)</b> |                         |                         |
| min   | 760mm / 29.9 inches     | 980mm / 38.6 inches     |
| max   | 1080mm / 42.5 inches    | 1300mm / 51.2 inches    |
| <b>Chest width (distance between laterals)</b>    |                         |                         |
| min   | 160mm / 6.3 inches      | 200mm / 7.9 inches      |
| max   | 280mm / 11.0inches      | 320mm / 12.6 inches     |
| <b>Hip support height (footplate to buttocks)</b> |                         |                         |
| min   | 460mm / 18.1 inches     | 620mm / 24.4 inches     |
| max   | 730mm / 28.7 inches     | 875mm / 34.4 inches     |
| <b>Hip width (distance between hip guides)</b>    |                         |                         |
| min   | 220mm / 8.7 inches      | 280mm / 11.0 inches     |
| max   | 330mm / 13.0 inches     | 390mm / 15.4 inches     |
| <b>Footplate angle</b>                            |                         |                         |
| Plantarflexion                                    | 10°                     | 10°                     |
| Dorsiflexion                                      | 10°                     | 10°                     |
| <b>Max knee contracture accommodated</b>          | 25°                     | 25°                     |
| <b>Tray height range (from top of hip pad)</b>    | 0 - 150mm / 0 -6 inches | 0 - 150mm / 0 -6 inches |
| <b>Tray angle adjustment</b>                      |                         |                         |
| Prone   | 45°                     | 45°                     |
| Supine  | 45°                     | 45°                     |
| <b>Product Weight</b>                             | 22kgs / 48lbs           | 25kgs / 55lbs           |
| <b>Product angle range</b>                        |                         |                         |
| Prone   | 0° to 80°               | 0° to 80°               |
| Supine  | 0° to 80°               | 0° to 80°               |
| <b>Stander footprint</b>                          |                         |                         |
| Length  | 978mm / 38.5 inches     | 1130mm / 44.5 inches    |
| Width   | 630mm / 24.8 inches     | 650mm / 25.6 inches     |

For more information please  
visit [leckey.com](http://leckey.com)

## TABLE OF SYMBOLS

| Symbol   | Meaning                       |
|--|-------------------------------|
|  The letters 'MD' in a bold, black, sans-serif font, enclosed in a black rectangular border.    | Medical Device                |
|  An icon of an open book with a lowercase letter 'i' positioned to the right of the book.       | Read the Instructions for Use |
|  The letters 'CE' in a bold, black, sans-serif font.  | CE mark                       |
|  A yellow triangular warning sign with a black exclamation mark in the center.                  | Warning                       |
|  A black silhouette of a factory with three chimneys.   | Manufacturer                  |
|  The letters 'SN' in a bold, black, sans-serif font, enclosed in a black rectangular border.    | Serial number                 |
|  The letters 'REF' in a bold, black, sans-serif font, enclosed in a black rectangular border. | Product Code                  |
|  An icon of a scale with 'Kg' on it, next to a black silhouette of a person.                  | Max occupancy weight          |
|  A black silhouette of a factory with three chimneys.   | Date of Manufacture           |
|  A black outline of a house.  | For indoor use only           |

| Symbol  | Meaning                              |
|---|--------------------------------------|
|  | Latex free                           |
|  | Unique Device Identification         |
|  | Machine wash- water temperature 70°C |
|  | Machine wash- water temperature 40°C |
|  | Tumble dry- low heat                 |
|  | Do not iron                          |
|  | Do not bleach                        |

## PRODUCT AND ACCESSORY CODES

| <b>Code</b> | <b>Mygo Stander</b>  |
|-------------|--|
| 143-1600    | Size 1 stander - with manual angle adjustment, PU chest pad, PU hip pad, PU knee supports, two piece footplate |
| 143-2600    | Size 2 stander - with manual angle adjustment, PU chest pad, PU hip pad, PU knee supports, two piece footplate |
| 143-1770-09 | Size 1 Cover pack - pink (contains chest pad, hip pad and knee pad covers)                                     |
| 143-1770-08 | Size 1 Cover pack - blue (contains chest pad, hip pad and knee pad covers)                                     |
| 143-1770-07 | Size 1 Cover pack - orange (contains chest pad, hip pad and knee pad covers)                                   |
| 143-2770-09 | Size 2 Cover pack - pink (contains chest pad, hip pad and knee pad covers)                                     |
| 143-2770-08 | Size 2 Cover pack - blue (contains chest pad, hip pad and knee pad covers)                                     |
| 143-2770-07 | Size 2 Cover pack - orange (contains chest pad, hip pad and knee pad covers)                                   |
| 143-1638    | Shoulder pad   |
| 143-1768-09 | Shoulder pad cover - pink  |
| 143-1768-08 | Shoulder pad cover - blue  |

---

|             |   |
|-------------|---|
| 143-1768-07 | Shoulder pad cover - orange                                     |
| 120-859     | Headrest hardware   |
| 143-1787    | Headrest cushion and cover - infection control (black)          |
| 137-800-05  | Headrest cushion and cover (black)                              |
| 137-699-05  | Headrest cushion and cover (black) (includes hardware)          |
| 143-1662    | Headrest - infection control (black) (include hardware)         |
| 143-1619    | Chest lateral hardware only (pair)                              |
| 143-1675    | Flipaway laterals hardware (pair)                               |
| 143-1673    | Complex lateral vertical - right hand side (single with cover)  |
| 143-1674    | Complex lateral vertical - left hand side (single with cover)   |
| 143-1780-09 | Size 1 chest/hip wraparound harness - pink                      |
| 143-1780-08 | Size 1 chest/hip wraparound harness - blue                      |
| 143-1780-07 | Size 1 chest/hip wraparound harness - orange                    |
| 143-1775-14 | Size 1 chest/hip wraparound harness - infection control (black) |
| 143-2780-09 | Size 2 chest/hip wraparound harness - pink                      |
| 143-2780-08 | Size 2 chest/hip wraparound harness - blue                      |
| 143-2780-07 | Size 2 chest/hip wraparound harness - orange                    |
| 143-2775-14 | Size 2 chest/hip wraparound harness - infection control (black) |
| 143-3780-09 | Size 3 chest/hip wraparound harness - pink                      |
| 143-3780-08 | Size 3 chest/hip wraparound harness - blue                      |
| 143-3780-07 | Size 3 chest/hip wraparound harness - orange                    |

- 143-3775-14      Size 3 chest/hip wraparound harness - infection control (black)
  
- 143-1798-09      Size 1 prone derotation hip belt - pink (includes hardware)
- 143-1798-08      Size 1 prone derotation hip belt - blue (includes hardware)
- 143-1798-07      Size 1 prone derotation hip belt - orange (includes hardware)
- 143-2798-09      Size 2 prone derotation hip belt - pink (includes hardware)
- 143-2798-08      Size 2 prone derotation hip belt - blue (includes hardware)
- 143-2798-07      Size 2 prone derotation hip belt - orange (includes hardware)
- 143-1783-09      Size 1 supine derotation hip belt - pink (includes hardware)
- 143-1783-08      Size 1 supine derotation hip belt - blue (includes hardware)
- 143-2783-07      Size 1 supine derotation hip belt - orange (includes hardware)
- 143-2783-09      Size 2 supine derotation hip belt - pink (includes hardware)
- 143-2783-08      Size 2 supine derotation hip belt - blue (includes hardware)
- 143-2783-07      Size 2 supine derotation hip belt - orange (includes hardware)
- 143-1663          Hip lateral hardware only (pair)
  
- 143-1776-09      Size 1 basic knee straps - pink
- 143-1776-08      Size 1 basic knee straps - blue
- 143-1776-07      Size 1 basic knee straps - orange
- 143-1776-14      Size 1 basic knee straps - infection control (black)
- 143-2776-09      Size 2 basic knee straps - pink
- 143-2776-08      Size 2 basic knee straps - blue
- 143-2776-07      Size 2 basic knee straps - orange
- 143-2776-14      Size 2 basic knee straps - infection control (black)

---

|             |  |
|-------------|--|
| 143-1778-09 | Split knee straps - pink - fits both sizes                     |
| 143-1778-08 | Split knee straps - blue - fits both sizes                     |
| 143-1778-07 | Split knee straps - orange - fits both sizes                   |
| 143-1690    | Extended knee brackets   |
| 143-1609    | Size 1 Mygo stander tray                                       |
| 143-1633    | Size 1 Mygo stander tray with bowl insert                      |
| 143-1610    | Size 1 Mygo stander tray with clear insert                     |
| 143-2609    | Size 2 Mygo stander tray                                       |
| 143-2633    | Size 2 Mygo stander tray with bowl insert                      |
| 143-2610    | Size 2 Mygo stander tray with clear insert                     |
| 143-1624    | Size 1 posterior support and pommel (fits size 1 stander only) |
| 143-2624    | Size 2 posterior support and pommel (fits size 2 stander only) |
| 143-1790-09 | Posterior support cover - pink                                 |
| 143-1790-08 | Posterior support cover - blue                                 |
| 143-1790-07 | Posterior support cover - orange                               |
| 143-1790-14 | Posterior support cover - infection control                    |
| 143-1792-09 | Pommel support cover - pink                                    |
| 143-1792-08 | Pommel support cover - blue                                    |
| 143-1792-07 | Pommel support cover - orange                                  |
| 143-1792-14 | Pommel support cover - infection control                       |
| 152-1600    | Sandals Size 1   |



|             |  |
|-------------|--|
| 152-2600    | Sandals Size 2   |
| 152-3600    | Sandals Size 3   |
| 143-1615    | Sandal raisers   |
| 143-1649    | Grab rail  |
| 143-1778-09 | Split knee straps - pink - fits both sizes                     |
| 143-1778-08 | Split knee straps - blue - fits both sizes                     |
| 143-1778-07 | Split knee straps - orange - fits both sizes                   |
| 143-1690    | Extended knee brackets   |
| 143-1609    | Size 1 Mygo Stander tray                                       |
| 143-1633    | Size 1 Mygo Stander tray with bowl insert                      |
| 143-1610    | Size 1 Mygo Stander tray with clear insert                     |
| 143-2609    | Size 2 Mygo Stander tray                                       |
| 143-2633    | Size 2 Mygo Stander tray with bowl insert                      |
| 143-2610    | Size 2 Mygo Stander tray with clear insert                     |
| 143-1624    | Size 1 posterior support and pommel (fits size 1 stander only) |
| 143-2624    | Size 2 posterior support and pommel (fits size 2 stander only) |
| 143-1790-09 | Posterior support cover - pink                                 |
| 143-1790-08 | Posterior support cover - blue                                 |
| 143-1790-07 | Posterior support cover - orange                               |
| 143-1790-14 | Posterior support cover - infection control                    |
| 143-1792-09 | Pommel support cover - pink                                    |

|             |  |
|-------------|--|
| 143-1792-08 | Pommel support cover - blue              |
| 143-1792-07 | Pommel support cover - orange            |
| 143-1792-14 | Pommel support cover - infection control |
| 152-1600    | Sandals Size 1                           |
| 152-2600    | Sandals Size 2                           |
| 152-3600    | Sandals Size 3                           |
| 143-1615    | Sandal raisers                           |
| 143-1649    | Grab rail                                |







**USA Distributor**

Sunrise Medical (US) LLC  
2842 N Business Park Avenue  
Fresno, CA 93727

[sunrisemedical.com](http://sunrisemedical.com)

**T:** 1-800-333-4000  
**F:** 1-800-300-7502  
**E:** [customseating@sunmed.com](mailto:customseating@sunmed.com)

**Canadian Distributor**

Sunrise Medical  
237 Romina Drive, Unit 3,  
Concord, ON, L4K 4V3

[sunrisemedical.ca](http://sunrisemedical.ca)

**T:** +1.800.263.3390  
**F:** +1.800.561.5834  
**E:** [mkt.canada@sunmed.com](mailto:mkt.canada@sunmed.com)

Please visit [leckey.com](http://leckey.com) for a full list of Leckey distributors.

---

James Leckey Design Limited  
19 Ballinderry Road  
Lisburn, BT28 2SA  
Northern Ireland

[leckey.com](http://leckey.com)

**(+44) 28 9260 0750**  
[hello@leckey.com](mailto:hello@leckey.com)



LS262-08