



Squiggles+

User Manual



Supporting
Children

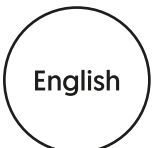

The Squiggles+ has been designed to offer the support your child needs in an upright, forward leaning (prone) or rearward leaning (supine) standing posture. The stander is modular in design and has been developed for use in school or at home. This manual shows how to quickly, safely and easily use your Squiggles+ functions. The instructions on the safety and maintenance will ensure that you will enjoy this product for a long time.

Contents

1. Intended Use	p.03
2. Certification	p.04
3. Warnings and Cautions	p.04
4. Terms of Warranty	p.06
5. Product History Record	p.06
6. Product Training Record	p.06
7. Safety Information	p.07
8. Precautions and Contraindications	p.08
9. How to unpack and assemble the standing system	p.09
10. Fitting the cushions	p.14
11. Clinical setup for postural management	p.18
12. Frequent adjustments for daily use	p.26
13. Cleaning & care information	p.30
14. Daily product inspection	p.31
15. Annual product inspection	p.32
16. Reissuing Leckey products	p.33
17. Product servicing	p.34
18. Technical information	p.35

1.0 Intended Use

Intended use

The devices are intended to assist children that cannot stand or maintain a standing position independently as part of a supported weight bearing program.

Indications for use

Squiggles+ is a standing frame which has been designed for children with disabilities aged 1–5 for use at home or in the classroom. The maximum user weight regardless of which chassis is used is 22kgs (48.4lbs). Suitable for:

- Children with disabilities such as Cerebral Palsy, traumatic brain injuries, muscular dystrophy and other conditions where supported standing programs are encouraged.
- Children presenting with developmental delay who are currently non-ambulating.
- Children where early intervention is indicated.

2.0 Certification

The Squiggles+ is classified as a Class I Medical Device under EU and UK regulations. As the manufacturer, James Leckey Design Limited, declares that this product conforms to the Medical Device Regulation (2017/745), UK Medical Device Regulations 2002, Medical Device Directive (93/42 EEC) and EN 12182:2012 Assistive products for persons with disability, general requirements and test methods.

Notice to the user and/or patient: Any serious incident that has occurred in relation to the device should be reported to the manufacturer and the competent authority of the Member State in which the user and/or patient is established.



NOTE: General user advice.
Not following these instructions may result in physical injury, damage to the product or damage to the environment!

3.0 Warnings and Cautions

1) WARNING TOPPLING HAZARD

- Never use the product on a sloping surface greater than 5 degrees.
- Always check operation of linear drives, gas struts, and motor drives before use.
- When adjusting the stander angle ensure there is adequate access space on all sides of the product.

- Always lock casters facing outwards before placing the user in the product.

2) WARNING FINGER TRAP HAZARD

- Ensure that the user or carer does not touch any moving joint or pivot that is not locked.
- While the user is in the product, the carer should strive to keep product adjustments to a minimum.

3) WARNING OCCUPANT SECURITY

- User transfers in and out of the product must be done with appropriate equipment and personnel.
- When transferring the user into the product, first use the pelvic band to secure the user.
- Ensure that all harnesses, sandal straps and chest pad are securely applied.

- If the user exhibits any form of distress, remove from the product as quickly as is safely possible.

4) CAUTION FINGER PINCH HAZARD

- While the user is in the product, the carer should strive to keep product adjustments to a minimum.
- Take care when assembling or adjusting the position of the stander components that your fingers do not get pinched when positioning stander components and tightening mountings.
- During product assembly and adjustment, the carer should avoid finger pinching risk of the product's joints or pivots.
- During transfers and adjustments, the carer should avoid the finger pinching risk of over-centre buckles and latches.

5) CAUTION DAILY CHECKS

- The stander is to be checked daily before use to ensure that all harnesses and stander components are securely attached.

- Always check operation of linear drives, gas struts, and motor drives before use.

6) CAUTION TRIP HAZARD WITH POWERED CHASSIS

- Before moving a powered stander ensure that battery charging connection is removed.

7) CAUTION CLEANING

- Clean the stander regularly to prevent the build-up of dirt. Accumulated dirt can prematurely wear the fabric components and encourage corrosion on the stander. Only use non-abrasive household cleaners and moist cloths, do not use running water on the upholstery whilst it is still attached to the seat. See section Cleaning & care information.

8) CAUTION CLEANING POWER WASHERS/HOSES

- Hoses and power washers are not to be used to clean the product. Stander with the electric lift system are not sealed against running water and may be damaged by water ingress. See section Cleaning & care information.

9) CAUTION SERVICING/ REPAIR OF ELECTRONIC COMPONENTS

- All electronic and electrical components are NOT user-serviceable. Servicing and repairs are only to be carried out by Leckey-authorized personnel.

10) CAUTION DISPOSAL

- When disposing of the product using a community waste disposal site, the frame and any electrical components should be disposed of separately.

11) CAUTION BRINGING INTO USE

- Before use, allow 2 hours for the product to acclimatise to room temperature.

4.0 Terms of Warranty

The warranty applies only when the product is used according to the specified conditions and for the intended purposes, following all manufacturers' recommendations (also see general terms of sales, delivery and payment). A three year warranty is provided on all Leckey manufactured products and components.

5.0 Product History Record

Your Leckey product is classified as a Class 1 Medical device and as such should only be prescribed, set up or reissued for use by a technically competent person who has been trained in the use of this product. Leckey recommend that a written record is maintained to provide details of all set-ups, reissue inspections and annual inspections of this product.

6.0 Product Training Records (Parents, Teachers & Carers)

Your Leckey product is a prescribed Class 1 Medical Device and as such Leckey recommend that parents, teachers and carers using the equipment should be made aware of the following sections of this user manual by a technically competent person:

7.0 Safety

12.0 Frequent Adjustments for Daily use

13.0 Cleaning and Care Information

14.0 Daily Product Inspection

Leckey recommend that a written record is maintained of all those who have been trained in the correct use of this product.

7.0 Safety Information

7.1 Always read instructions fully before use.

7.2 Users should not be left unattended at any time whilst using Leckey equipment.

7.3 Only use Leckey approved components with your product. Never modify the product in any way. Failure to follow instructions may put the user or carer at risk and will invalidate the warranty on the product.

7.4 If in any doubt to the continued safe use of your product or if any parts should fail, please cease using the product and contact our Customer Care Team or local dealer as soon as possible.

7.5 Carry out all positional adjustments and ensure that they are securely fastened before you put the user into this product. Some adjustments may require the use of a tool which is provided with each product. Keep all tools out of reach of children.

7.6 When putting the user into the stander both for positional and safety reasons, always secure the pelvic and chest support harnesses first.

7.7 When the product is stationary ensure that all castors are locked and facing away from the base as this will improve product stability. This is especially important when the support frame is in a reclined position.

7.8 When the product is in use please ensure that the angle adjustment foot pedal are locked off and cannot be adjusted accidentally, especially if there are children in the area.

7.9 When the Leckey Squiggles+ is used on the Pivot chassis we do not recommend that users is moved over uneven surfaces when in the equipment. All due care and attention should be taken if transporting the user in and out of the stander.

7.10 Never leave the product on a sloping surface, greater than 5 degrees. Always remember to lock all the castors.

7.11 Although the Pivot stander is fitted with castors this is not a mobility device. Always place the user in an upright position before moving the stander. Hold the push handle when moving the stander.

7.12 The product contains components which could present a choking hazard to small children. Always check that locking knobs and bolts within the child's reach are tightened and secure at all times.

7.13 Leckey products comply with fire safety regulations in accordance with EN12182. However the product contains plastic components and therefore should be kept away from all direct sources of heat including naked flames, cigarettes, electric and gas heaters.

7.14 Do not place hot objects greater than 40°C on the tray.

7.15 Clean the product regularly. Do not use abrasive cleaners. Carry out maintenance checks on a regular basis to ensure your product is in good working condition.

7.0 Safety

7.16 The product is designed for indoor use and when not in use should be stored in a dry place that is not subjected to extremes of temperature. The safe operating temperature range of the product is +5 to +40 deg Celsius.

7.17 Please be aware of a gap on the underside of the tray where a child could insert their finger between the metal bracket and the base of the plastic tray.

8.0 Precautions and Contraindications

Precautions

- Fixed spinal deformities such as scoliosis or kyphosis
- Severe muscle contractures
- Severe muscular or skeletal asymmetry including hip dislocation
- Progressive and muscle wasting conditions
- High risk or recent history of bone fractures
- High risk of pressure related injury or open sores
- Strong, uncontrolled movement patterns

- Poorly controlled seizure activity
- Children dependent on the use of percutaneous endoscopic gastrostomy
- Medical instability including compromised respiratory or cardiovascular function
- Dependant on 3rd party life-sustaining apparatus such as oxygen tanks
- Significant learning disabilities and/or behavioural issues

Contraindications

- Children experiencing pain or discomfort that cannot be resolved by adjustment of support/positioning
- Children with hip/ knee flexion contracture beyond the limits of the stander

All precautions and contraindications are taken at the discretion of the prescribing clinician or parent. Leckey recommends a trained and experienced clinician to be present during all initial assessment, set ups, configurations, and reissues to minimise risk.

9.0 How to unpack & assemble the standing system

9.1 Folding and unfolding the pivot chassis

The Pivot Chassis can be easily folded for storage or transportation. To unfold, release the levers **A** shown by pressing them together, rotate the rear tubes until the levers engage in the locked position. To fold the chassis simply reverse this procedure.

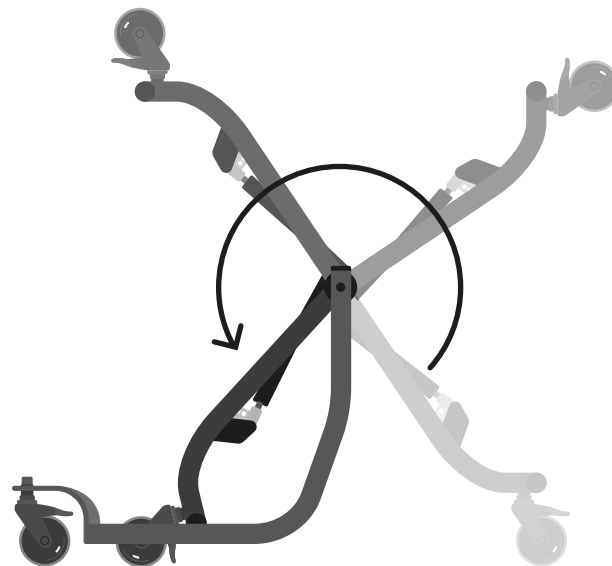
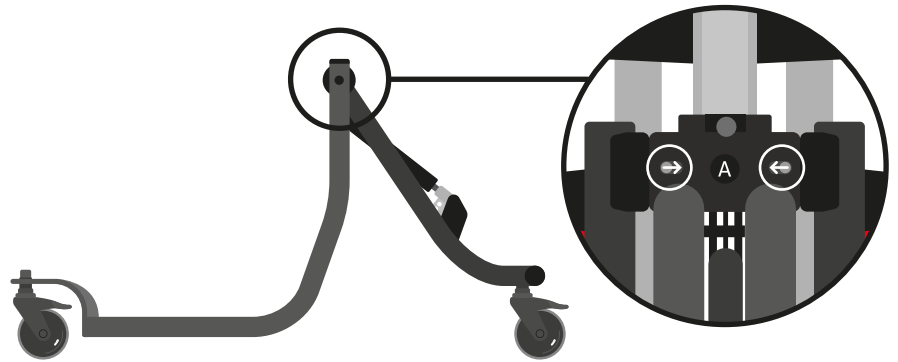

Always remove the standing support frame before trying to fold the chassis.

Always use caution to ensure fingers do not become trapped when folding and unfolding the pivot chassis.

The Squiggles+ can be used as a prone, supine or upright stander and has been designed to fit with a pivot chassis.

9.2 Attaching stander to pivot chassis

To attach the stander to the Pivot Chassis, pull the locking pin out **A**, slide the central spine into the receiving bracket until it is fully engaged, release the pin allowing it to snap back into place.

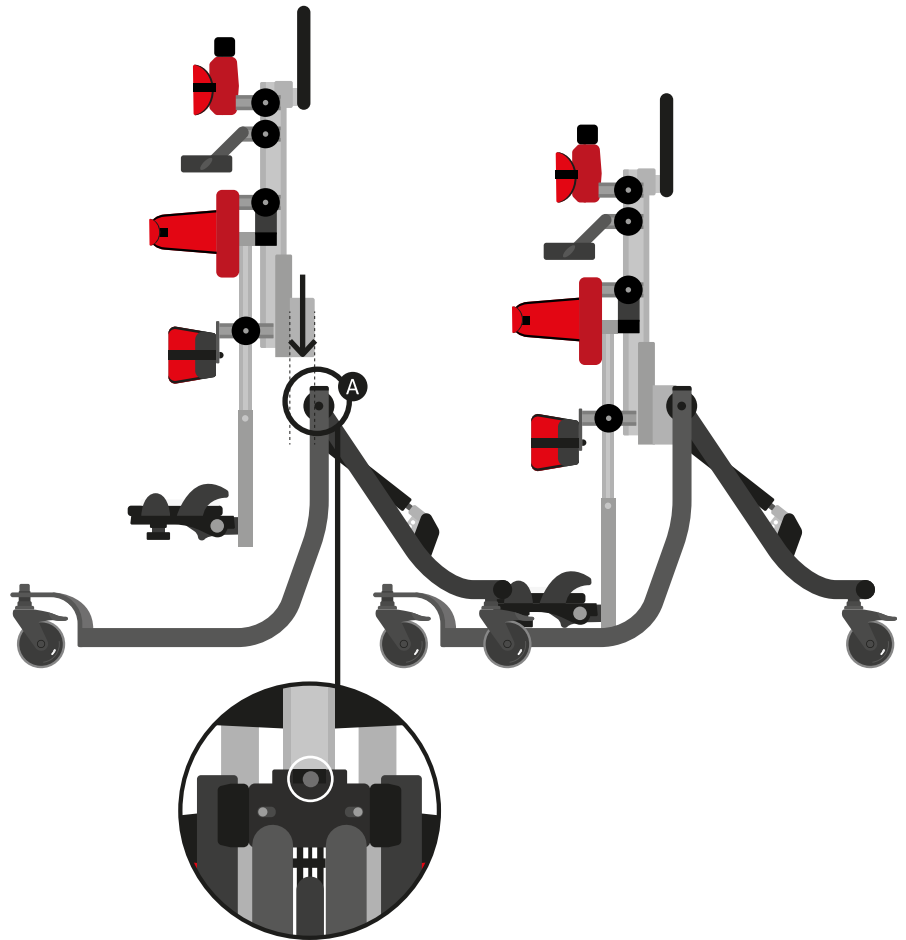

Always make sure the locking pin is fully engaged before you place the child in the stander.

9.3 Attaching the headrest

To attach the Leckey headrest first open the locking lever by pressing the safety button and pulling the handle **A**. Then slide the stem into the receiving bracket on the central spine, set to the desired position and secure using the locking handle **B**.

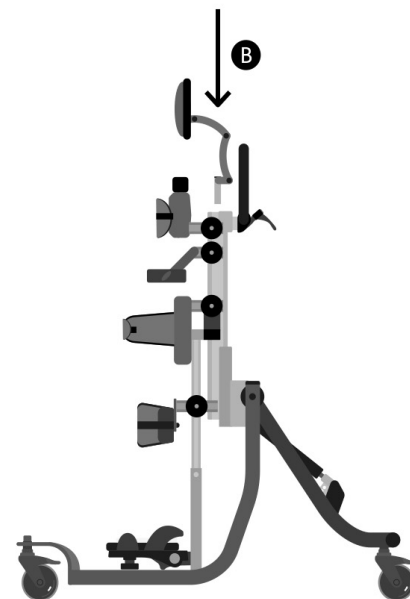
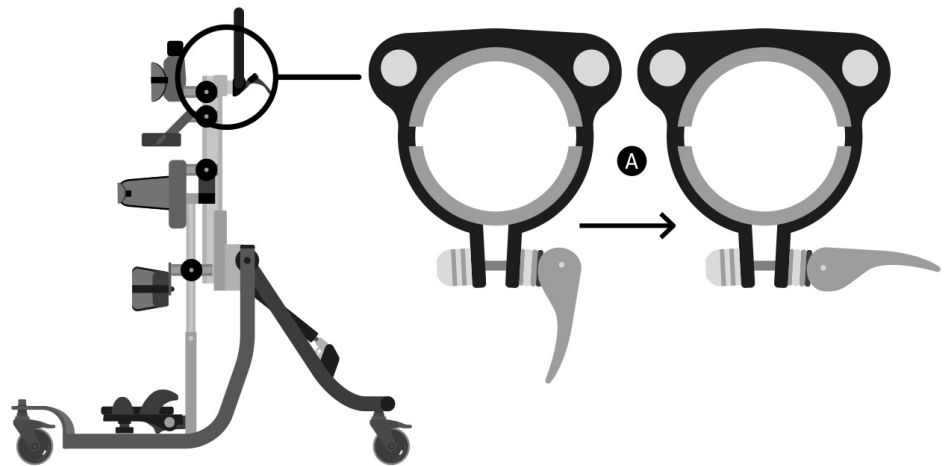

The product contains components which could present a choking hazard to small children. Always check that locking knobs and bolts within the child's reach are tightened and secure at all times.

9.4 Inserting sandal attachment bolt

Insert the required attachment bolt **A** along with the retention plate **B**. Place a rubber lid **C** on, both, the top and bottom of the sandal. Fasten using the four screws **D** provided. To remove or replace the attachment bolt, reverse this process.

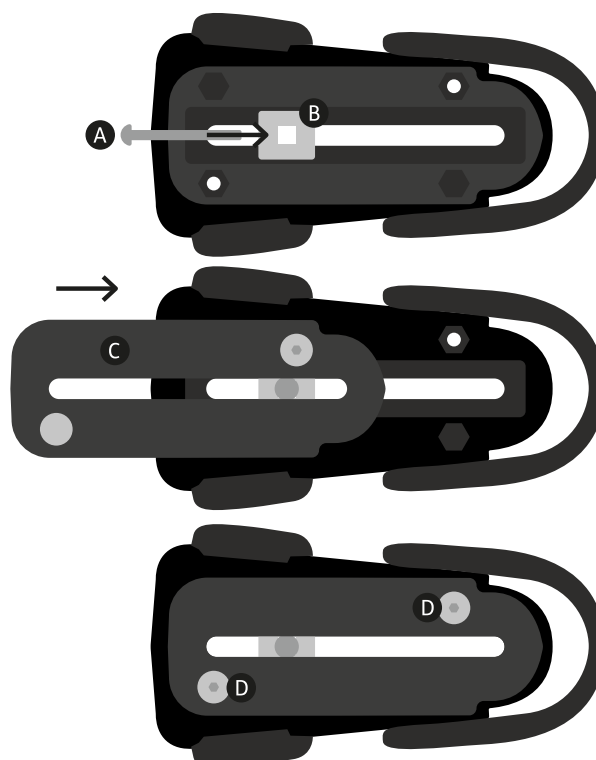

9.5 Attaching the sandals

Place the sandal so that the attachment bolt goes through the slot in the footplate. To secure, on the underside of the footplate place the rubber washer **A**, followed by the metal washer **B** and then the knob **C** onto the attachment bolt. To position the sandals simply loosen the knob under the footplate, select the position you require and re-fasten the knob.

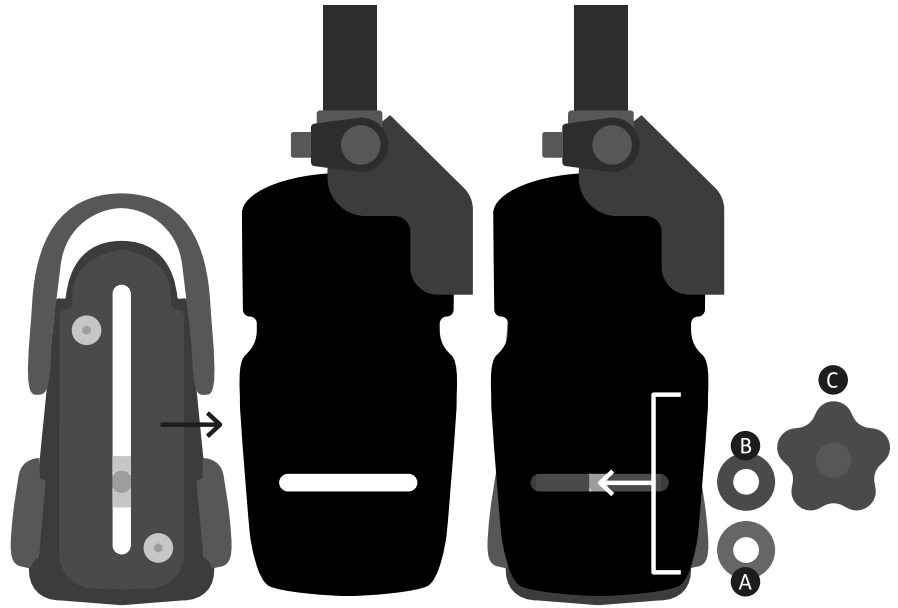

9.6 Assemble the tray

To attached the arms to the tray brackets, loosen the knob, place the moulding to the inside of the tray plate so the plastic teeth mesh. **A** Replace the knob on the outside and secure. Repeat on other side. Ensure both horizontal tubes are aligned so they locate in the tray bracket receivers. **B**

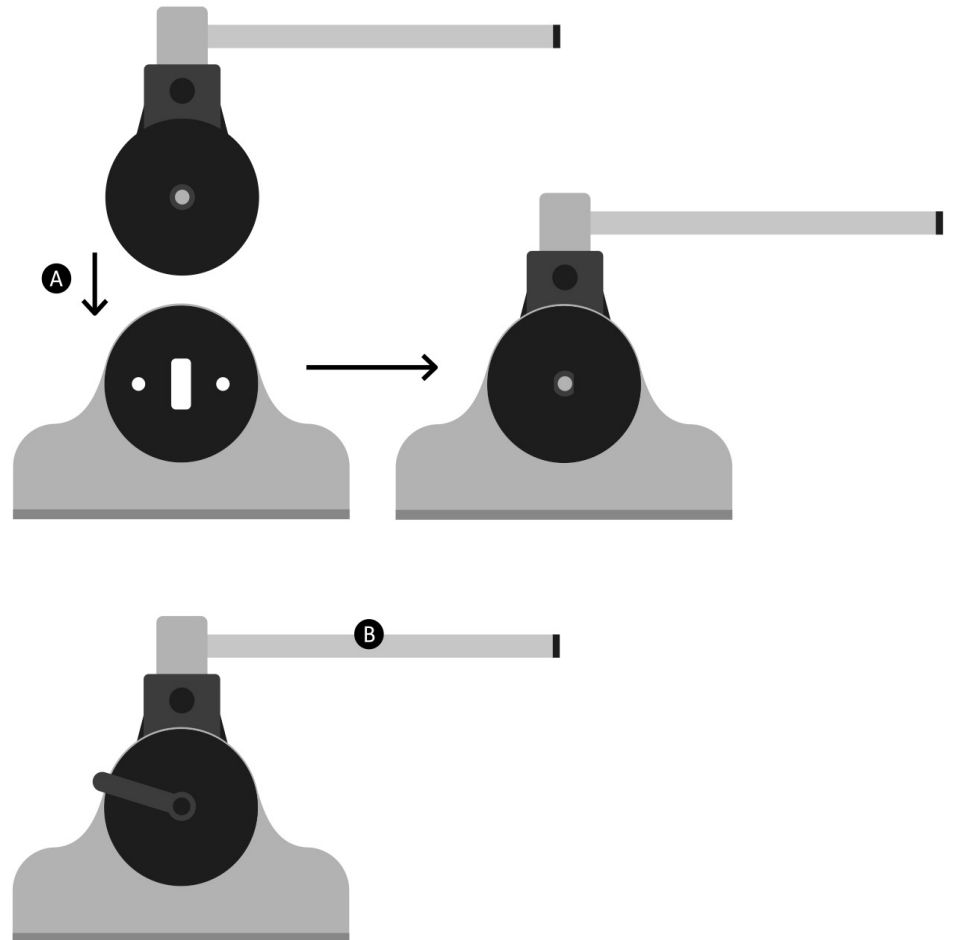

!
Please be aware of a gap on the underside of the tray where a child could insert their finger between the metal bracket and the base of the plastic tray.

9.7 Attaching the tray in prone and supine

The tray is attached to the stander by inserting the tubes into the receiving brackets. Once the tray is located in position the knobs should be tightened. The cut out of the tray should always be facing the child. To attach the tray whilst in the prone version, ensure that the tray receiving tubes are at their maximum height.



Always use caution to ensure the child's hands or arms do not become trapped when inserting the tray.

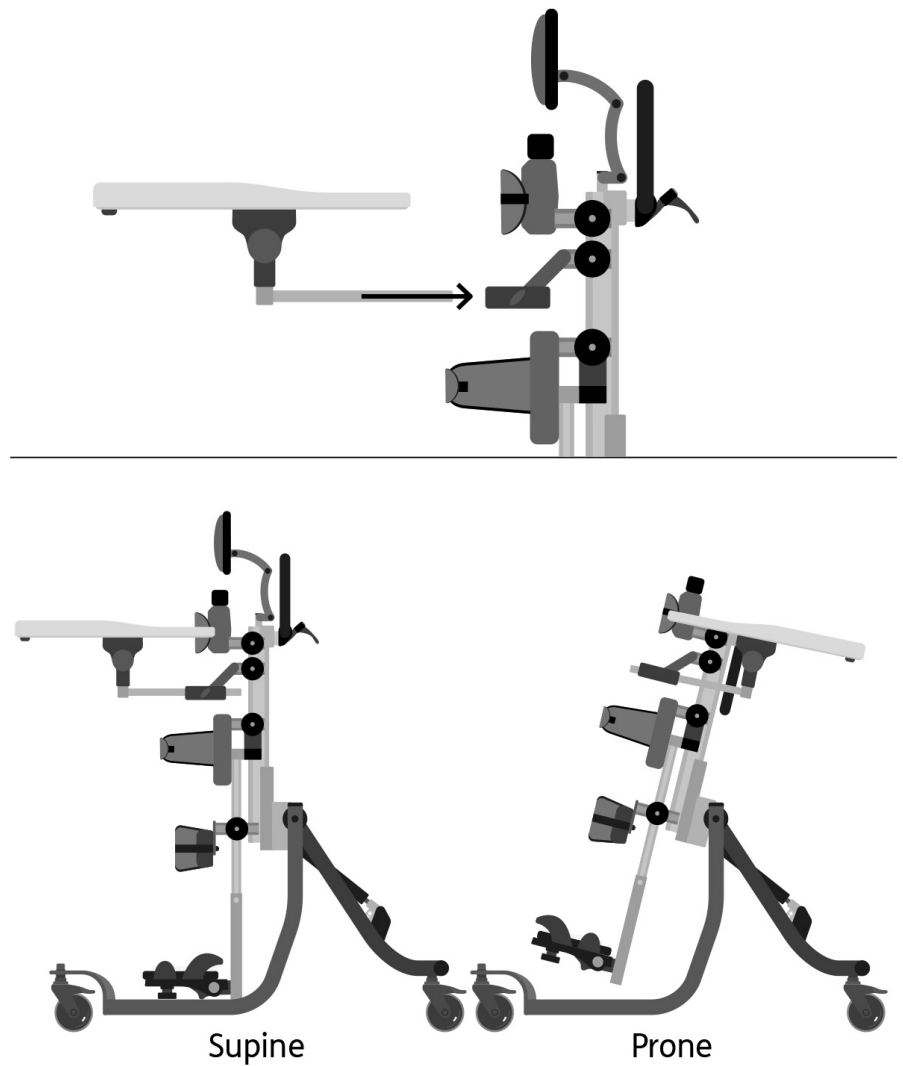

9.8 Attaching the grab rail

To attach the grab rail, inset the receiving brackets **A** in the tray slot and secure with the plastic knob **B**. Repeat on the other side and then sleeve the tubes into the tube **C** and tighten the plastic knob **D**.

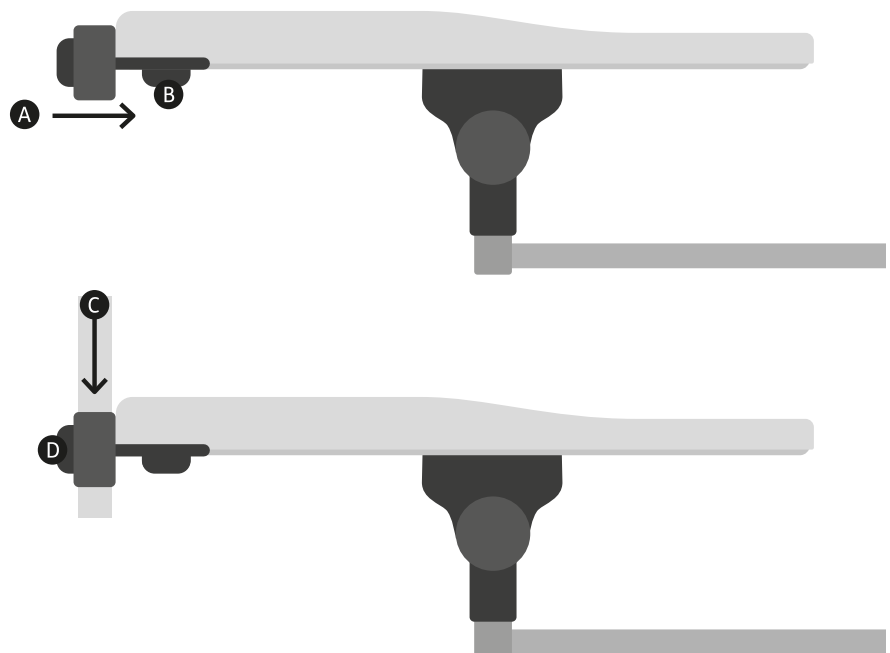

10.0 Fitting the Cushions

10.1 Hip cushions

Place the cushion centrally on the chest/hip support plate **A**. Feed the upper tab, which has the Velcro attached, over the top of the moulding and Velcro in place. Bring the lower tab under the support and attach the upper tab using the Velcro panels **B**.

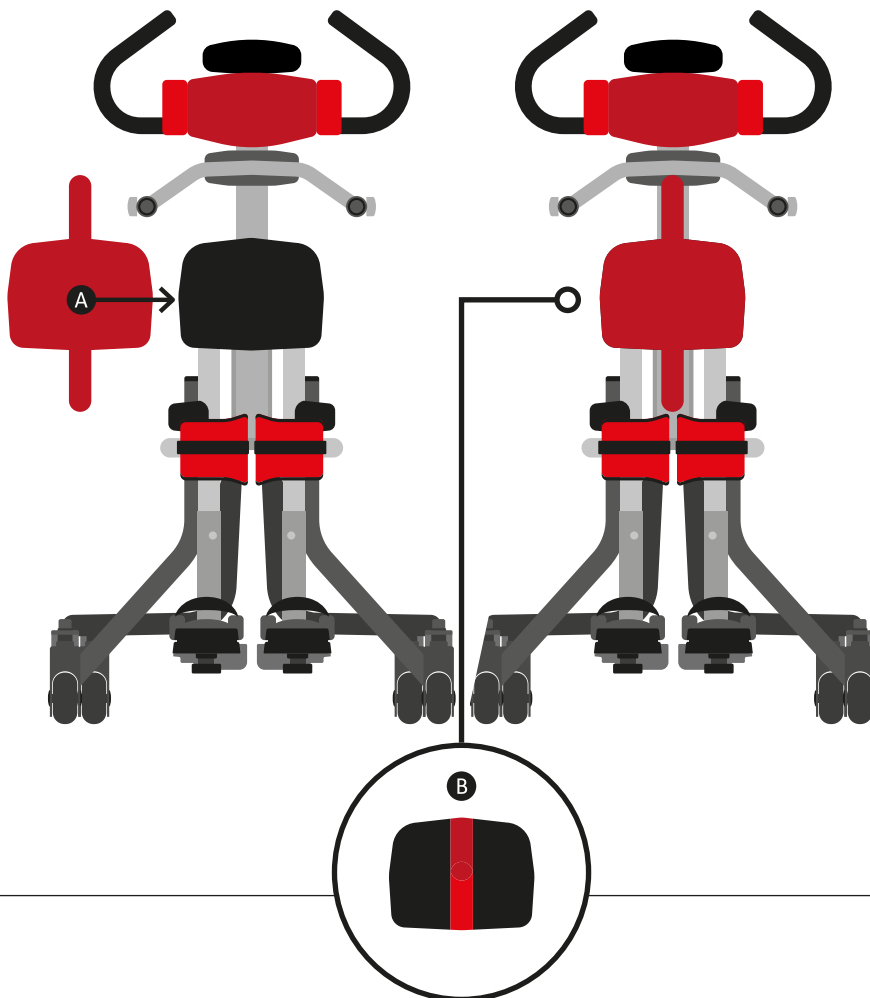

10.2 Lateral cushions

To attach the lateral support padded cushions, simply slide the cushions on with the padded side towards the inside of the stander. Sleeve the plastic buckle **A** through the slot in the cover. Then fasten poppers together at the back.

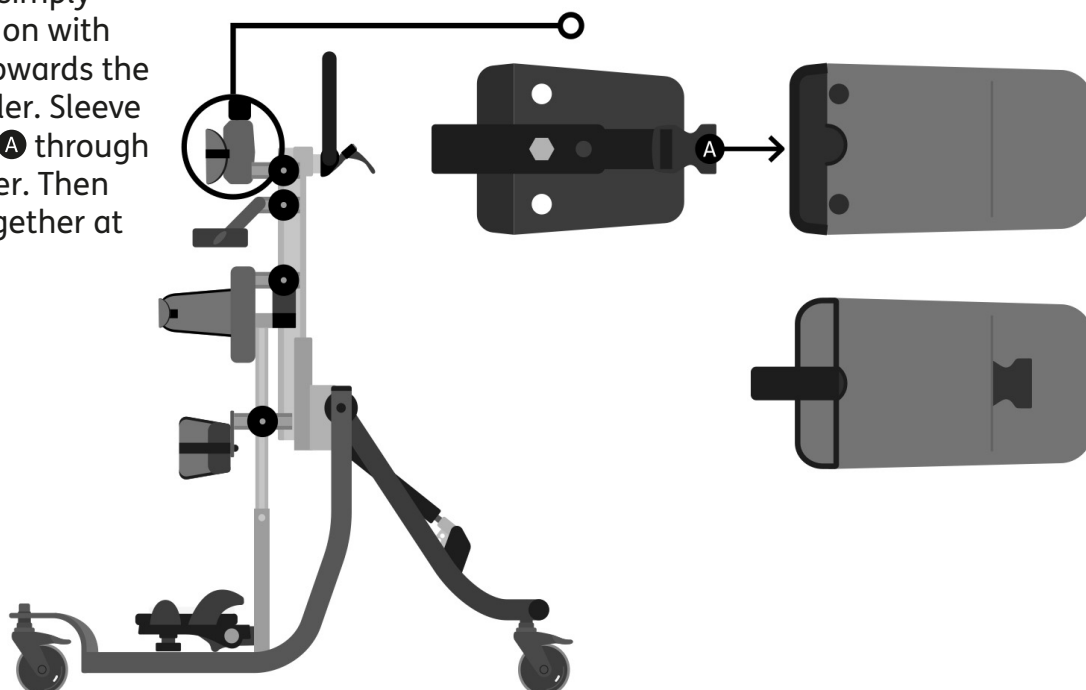

10.3 Chest support harness

The Chest support can be attached by clipping the male buckle into the female buckle at either side of the lateral supports.

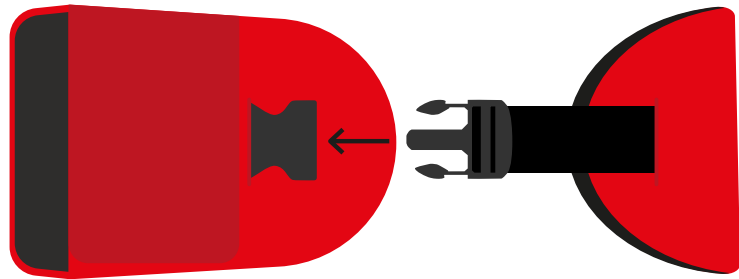

10.4 Pelvic harness

To attach the pelvic harness, simply slide the left and right sides of the harness over the lateral supports. Sleeve the plastic buckles through the slots in the harness **A**. Then fasten the poppers together at the back of the harness.

Finally pull the Velcro receiving straps around the user to secure the user in the harness. **B**

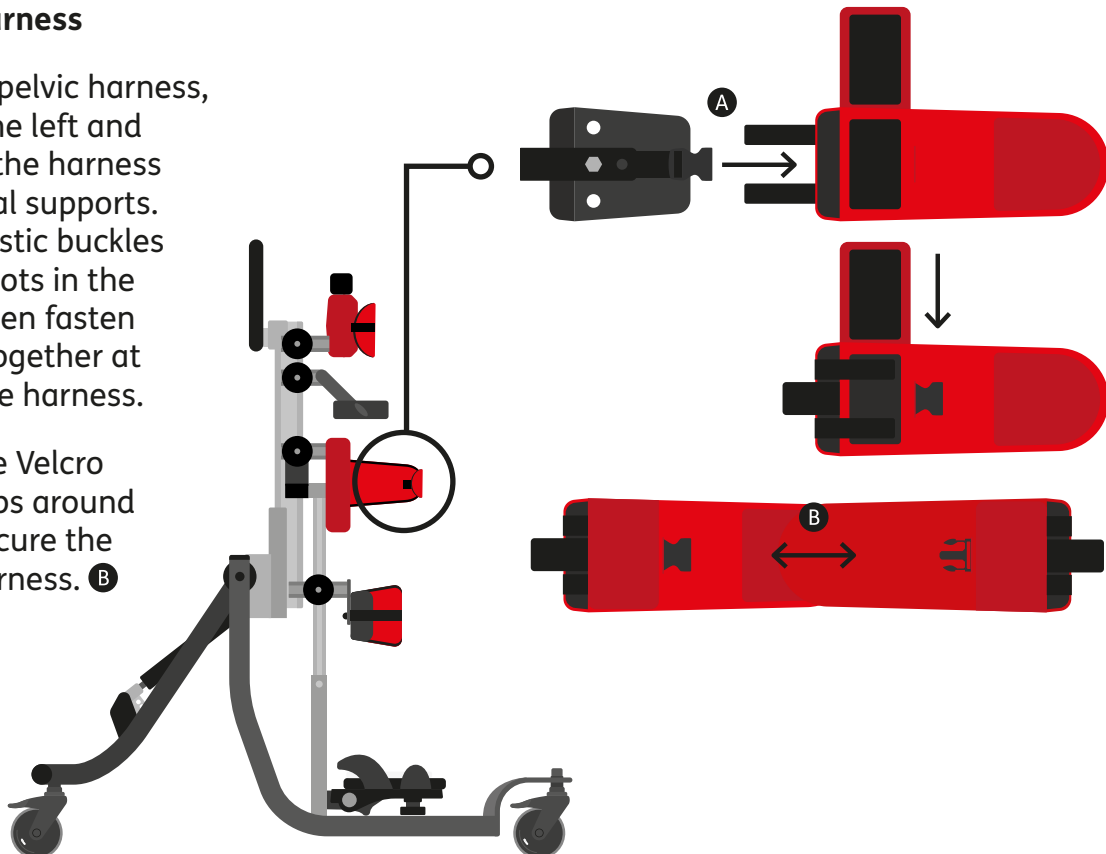

10.5 Hip Support harness

The hip support should be attached around the pelvic harness as an additional safety support should the Velcro on the pelvic harness begin to wear. It can be attached by clipping the male buckle into the female buckle at either end of the pelvic harness.

To adjust the tension lift the front panel, adjust the straps to the required length and then replace the panel.

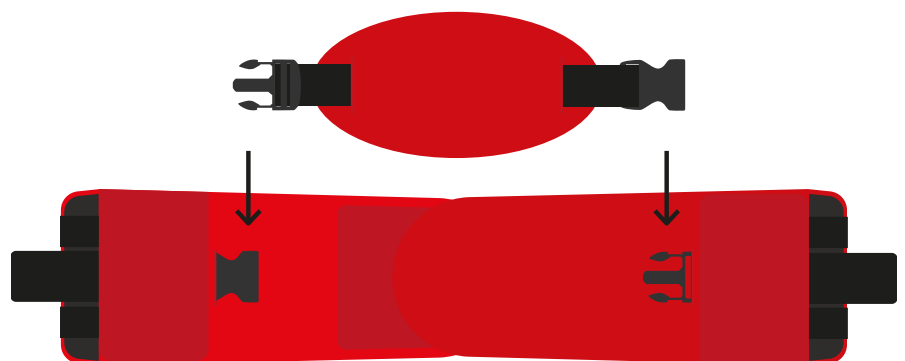

10.6 Knee support pads

Open the knee supports fully. Insert child's knee into place **A**. Wrap small strap over the knee, then bring the longer wrap over to ensure a snug fit over the knee **B**. Velcro in place and secure with buckle **C**. Once knee is in correct position, secure cam-lock for further repeatability.

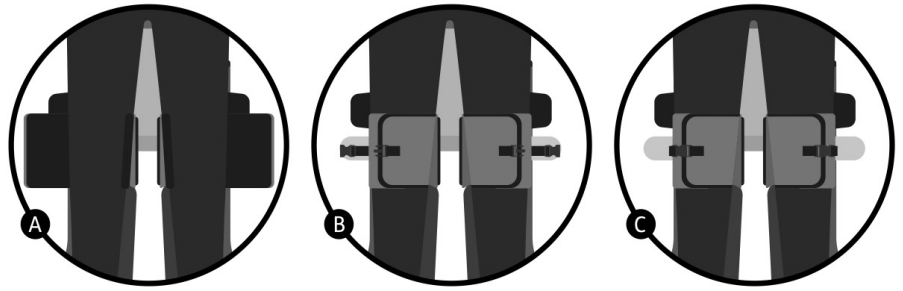

10.7 Padded Spine Cap

Place the padded spine cap over the spine of the standing support and place the plastic loops around the adjustment knobs.

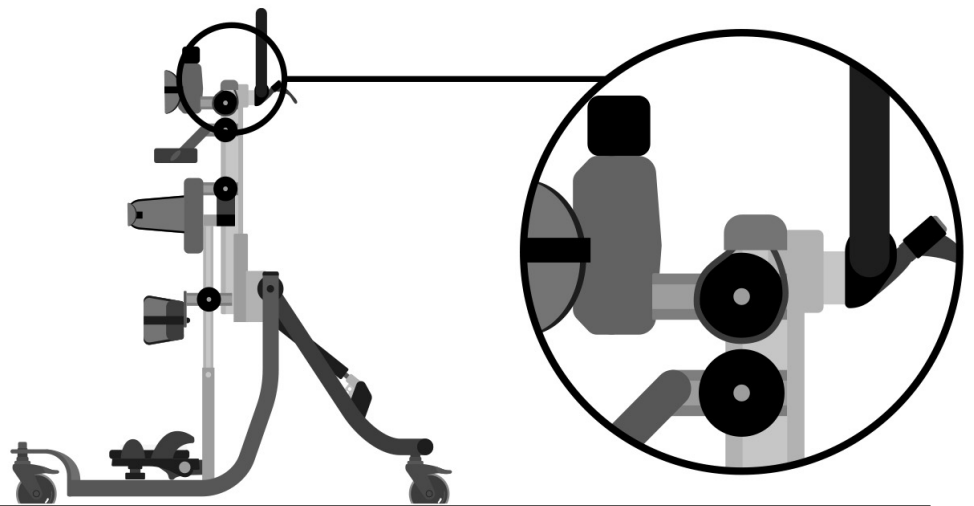

10.8 Headrest cushion

To attach the headrest cushion, place the cushion onto the head support plate, then Velcro and bring the lower flap under the plate and Velcro the two fasteners in place.

Contoured headrest

To attach the contoured headrest cushion, place the cushion onto the head support plate and popper the top flap in place. Bring the lower flap under the plate and Velcro the two fasteners in place.

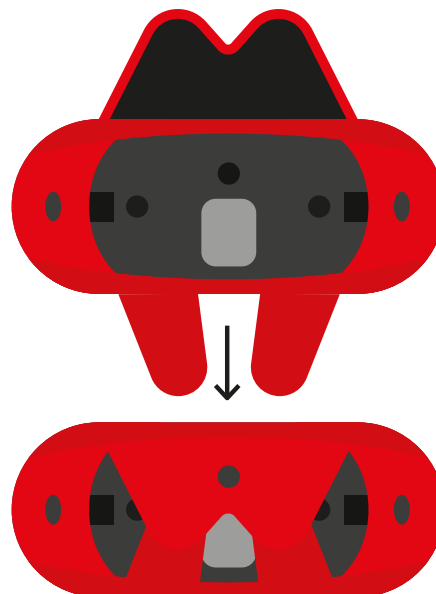

10.9 Headrest Laterals

To attach the headrest lateral covers, simply slide the covers on with the padded side towards the inside of the stander **A**. Then fasten the poppers together at the back. **B**

Clinical setup for postural management 11

The clinical setup of the product should be completed by a technically and clinically competent person who has been trained in the use of the product. Leckey recommend a written record is maintained of all clinical set-ups for this product.

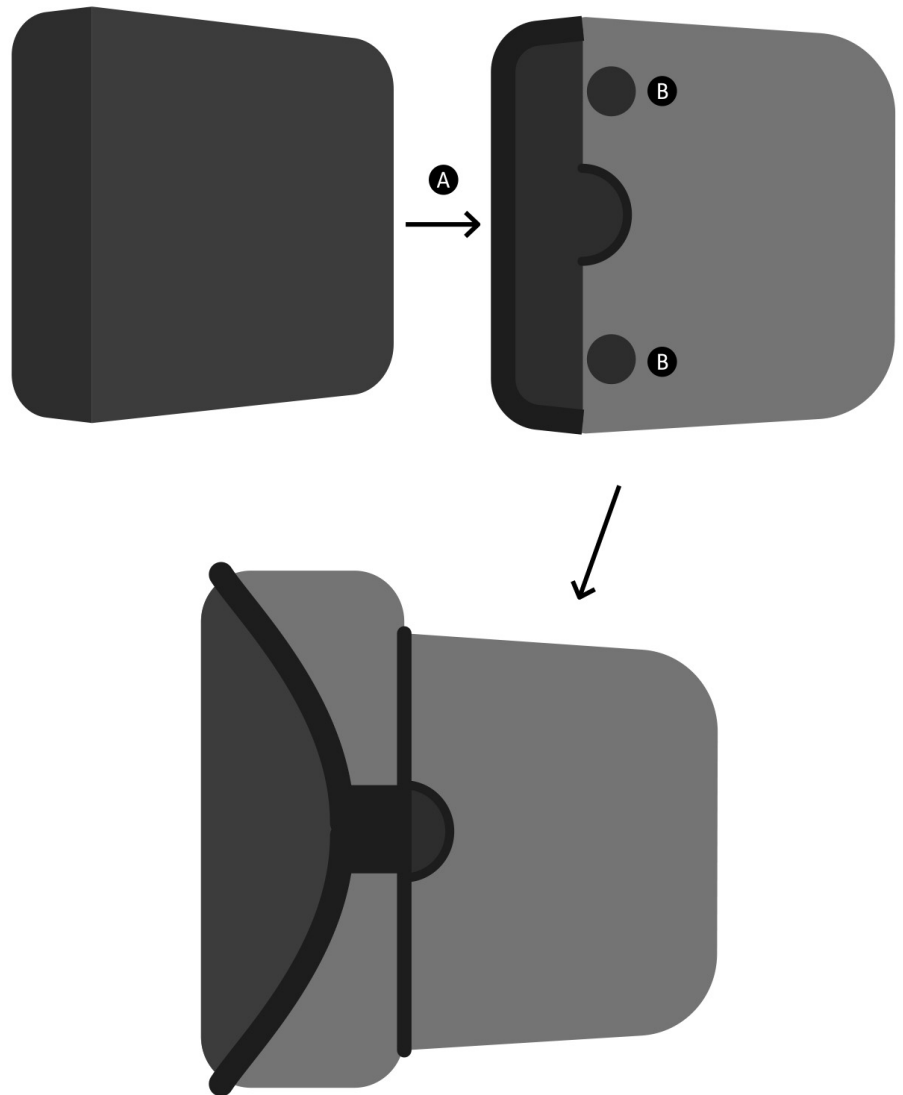

11.0 Clinical setup for postural management

11.1 Setting the Height

Set the height first by placing the child in a lying position on a mat. Measure the distance from the child's feet to their hips. **A**

The height between the centre of the hip moulding and the top of the sandal should be set to this height by adjusting the leg support. **B**

Measure the distance from the child's feet to just under their axilla **C** and the height between the top of the chest support and the sandal should be set to this distance. Adjust this distance by adjusting the hip support. **D**

It's recommended to adjust the height whilst the frame is in an upright position

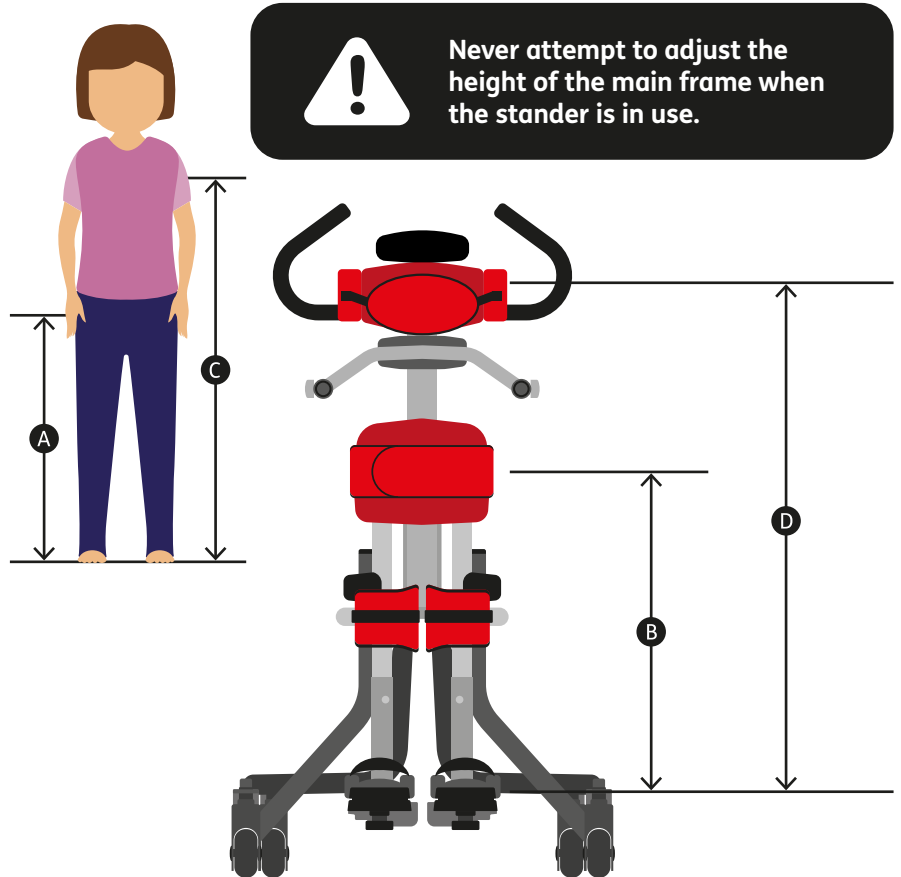

11.2 Adjusting the overall height

The overall height of the standing support can be adjusted by loosening the bolt on the back of the main frame with the multi-tool **A**. Sliding the inner stem to the desired height and re-tightening the allen bolt. A calibration strip is fitted on the side of the inner frame to help you record the selected positions of the supports. There is also a safety stop at the maximum height.

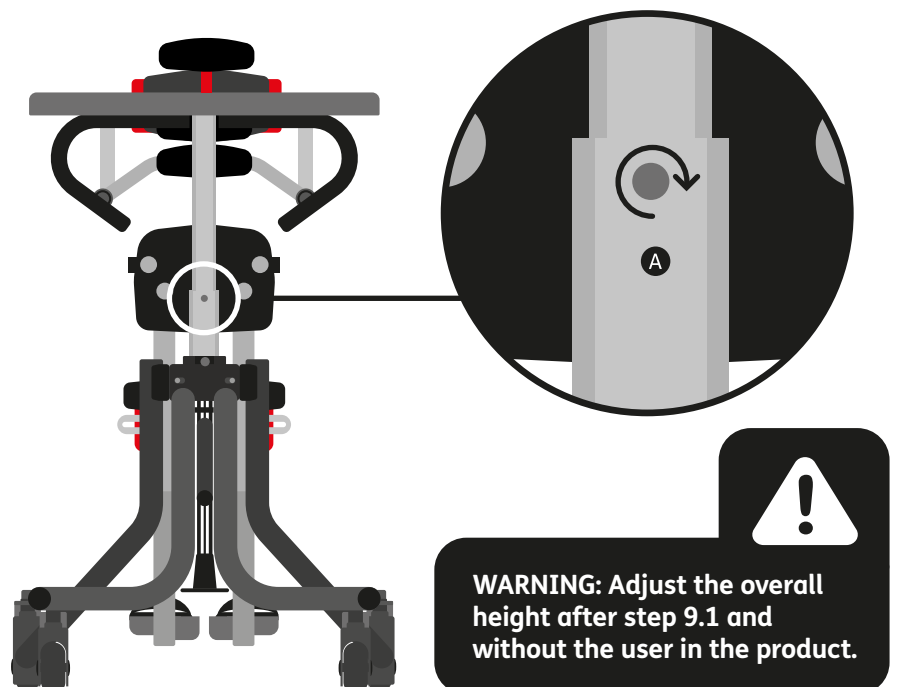

11.3 Adjusting the push handle

The push handle height can be adjusted by loosening the Allen bolt **A** at the attachment point to the stander, adjusting to the desired height then re-tightening the Allen bolt. The angle of the push handles can be adjusted by loosening lever **B** at the attachment point to the stander. Rotate the push handle to the desired position, then secure the lever to original orientation.



To prevent finger nipping always hold the push handle with one hand whilst making the adjustment with your other hand.

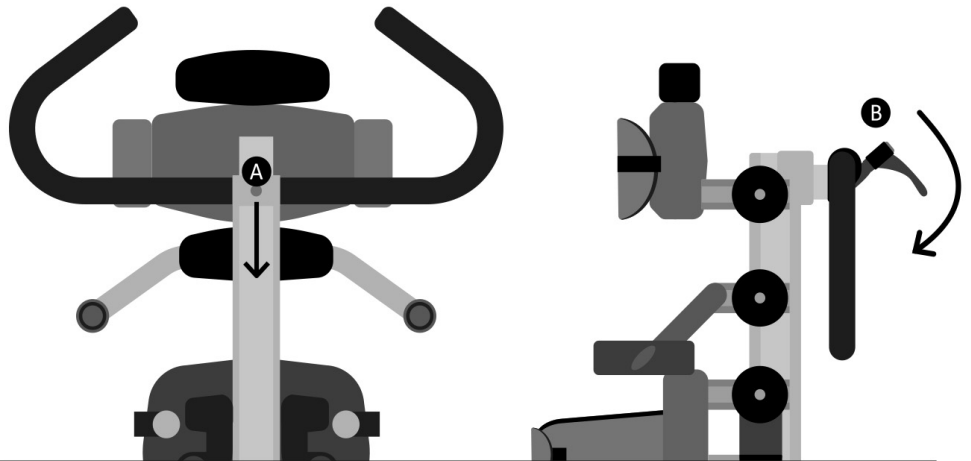

11.4 Adjusting the chest and hip supports

To adjust the chest support rotate both knobs **A** in an anticlockwise direction as shown. Set to the required position and then re-tighten both knobs in a clockwise direction as shown **B**.

To adjust the hip support loosen the 4 locking bolts (2 either side) **C**. Rotate both knobs **D** in an anticlockwise direction as shown. Set to the required position and re-tighten both knobs in a clockwise direction as shown **E**. Finally re-tighten the 4 locking bolts.

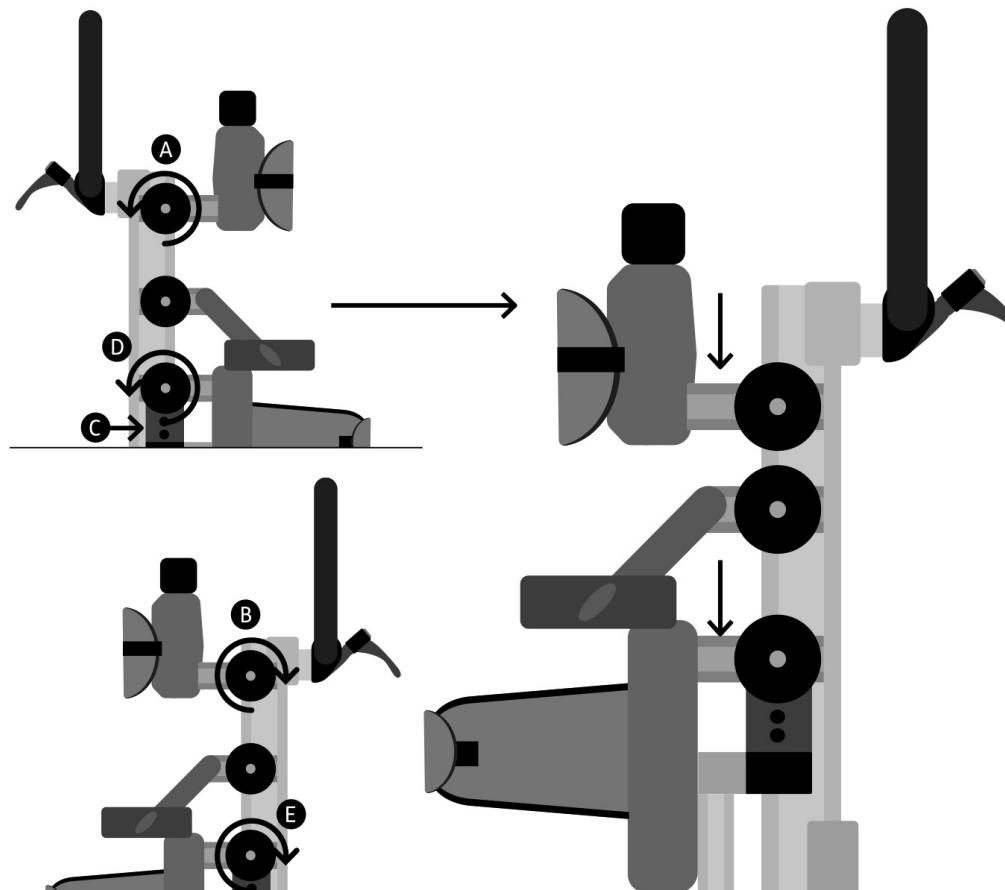

Always use caution to ensure fingers do not become trapped when adjusting the chest and hip supports.

11.5 Lateral supports

Loosen the hand knob **A** to adjust the width of the lateral supports and re-tighten when you have achieved the desired position. If, the lateral supports are attached with bolts instead of hand knobs they can be adjusted with the multi tool.

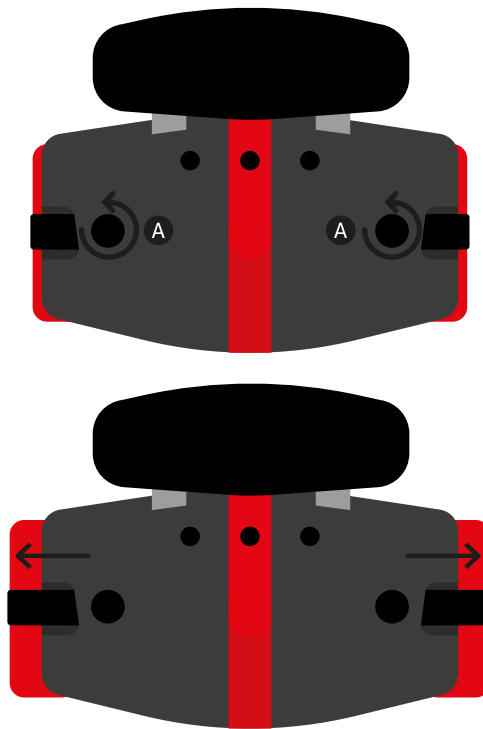



Always use caution to ensure fingers do not become trapped when adjusting the lateral supports.

11.6 Adjusting the pelvic harness

To adjust the pelvic harness pull the Velcro receiving straps around the user until the desired position is achieved.

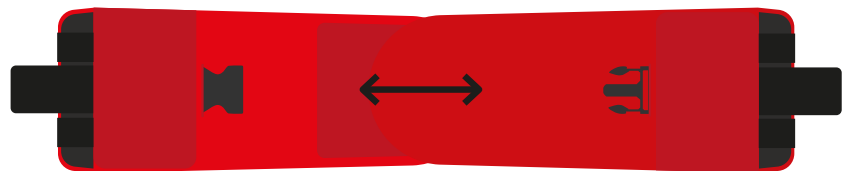

11.7 Chest and hip support harness

To change the width of the chest harness, lift the front cover, adjust the Velcro straps and set to the desired width and replace the cover.



Always make sure the plastic buckles are fully engaged when using the chest harness.

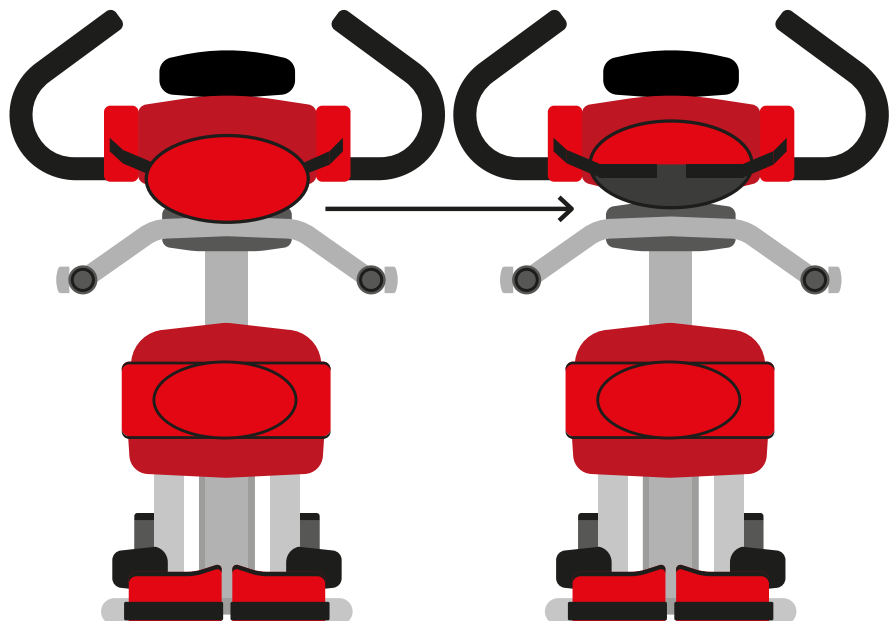

11.8 Adjusting the sternum pad

The sternum pad can be raised to provide additional support to assist thoracic extension. This also allows the chest support to be set lower to enable greater freedom of arm movement. The sternum plate is adjusted by loosening the two bolts at the front of the chest plate with the multi-tool, set to the desired height and re-tighten.



Always use caution to ensure fingers do not become trapped when adjusting the sternum pad.

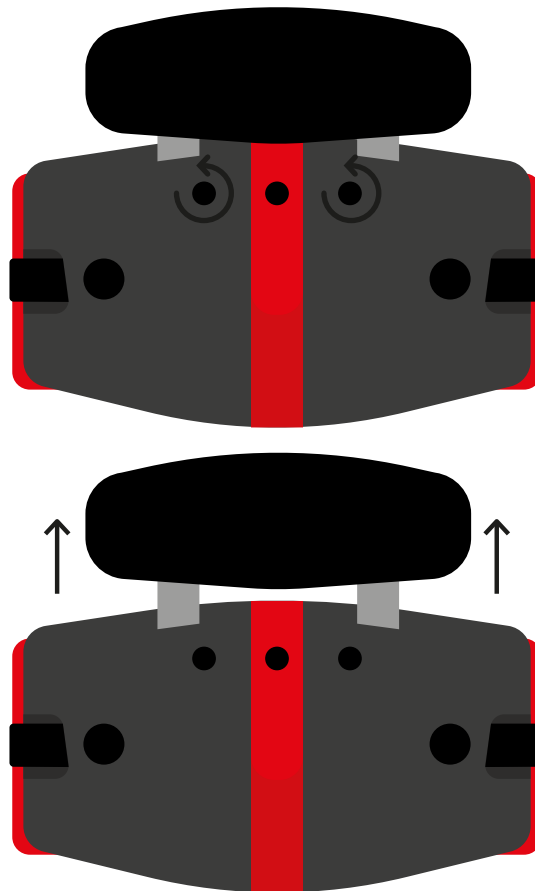

11.9 Adjusting the height, depth and angle of the knee cups

Each knee cup can be positioned independently. To adjust the height, depth and angle of the knee cups, loosen screw **A**, select the height, angle and depth required and re-tighten the screw securely. To adjust the width of the knee cup loosen screw **B**, set to the desired width then re-tighten.

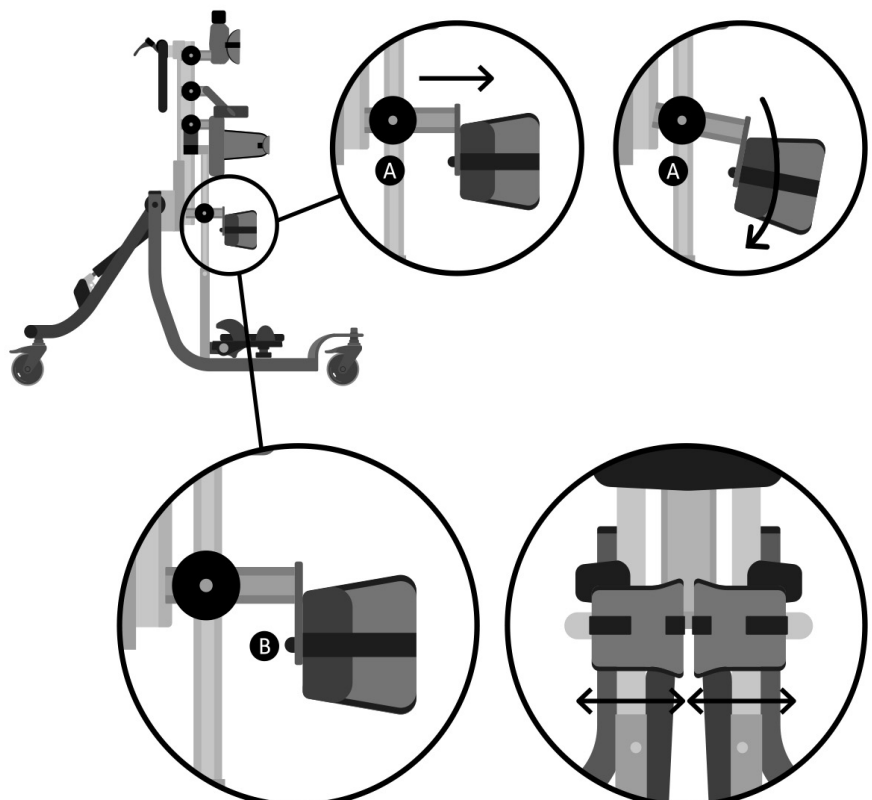

11.10 Headrest adjustment

The headrest should only be used when the child is in supine standing. To adjust the height, depth and angle of the contoured headrest, loosen the hand knobs **A** and when set to the desired position re-tighten the knobs.



Always use caution to ensure fingers do not become trapped when height adjusting the headrest.

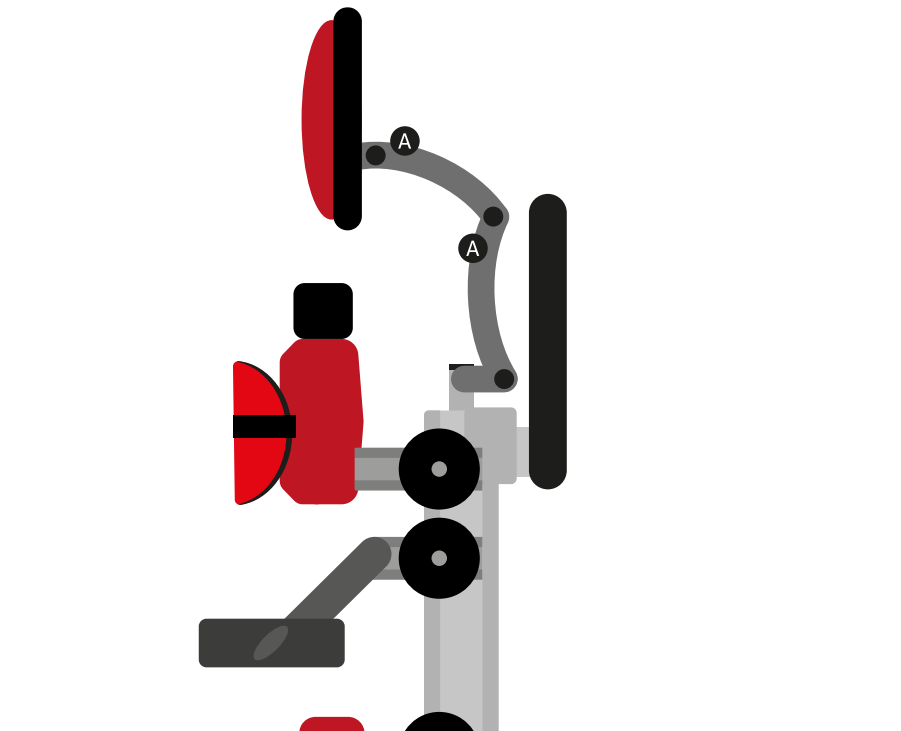

11.11 Flat headrest lateral adjustment

To adjust the width of the laterals loosen plastic knob **A** to desired position and tighten securely.

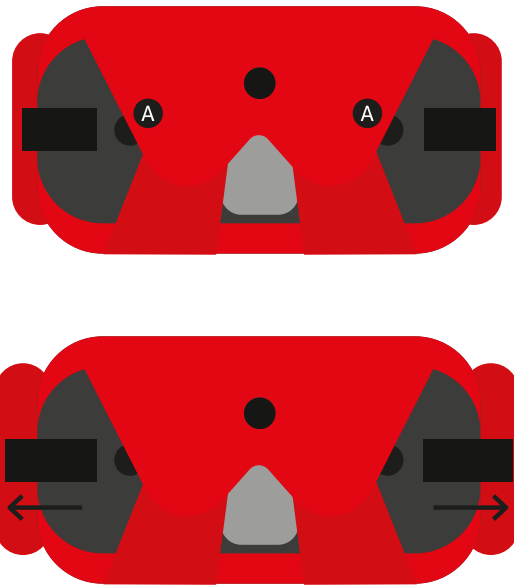

11.12 Sandals positioning

To position the sandals simply loosen the knob **A** under the footplate, select the position you require and re-fasten the knob. To position the user's feet in the sandals secure the Velcro straps provided so the foot is held in place. The straps should be placed over the bridge of the foot and over the toes. The front strap can be fed through one of two slots on either side of the sandals, depending on the size of the user's feet.

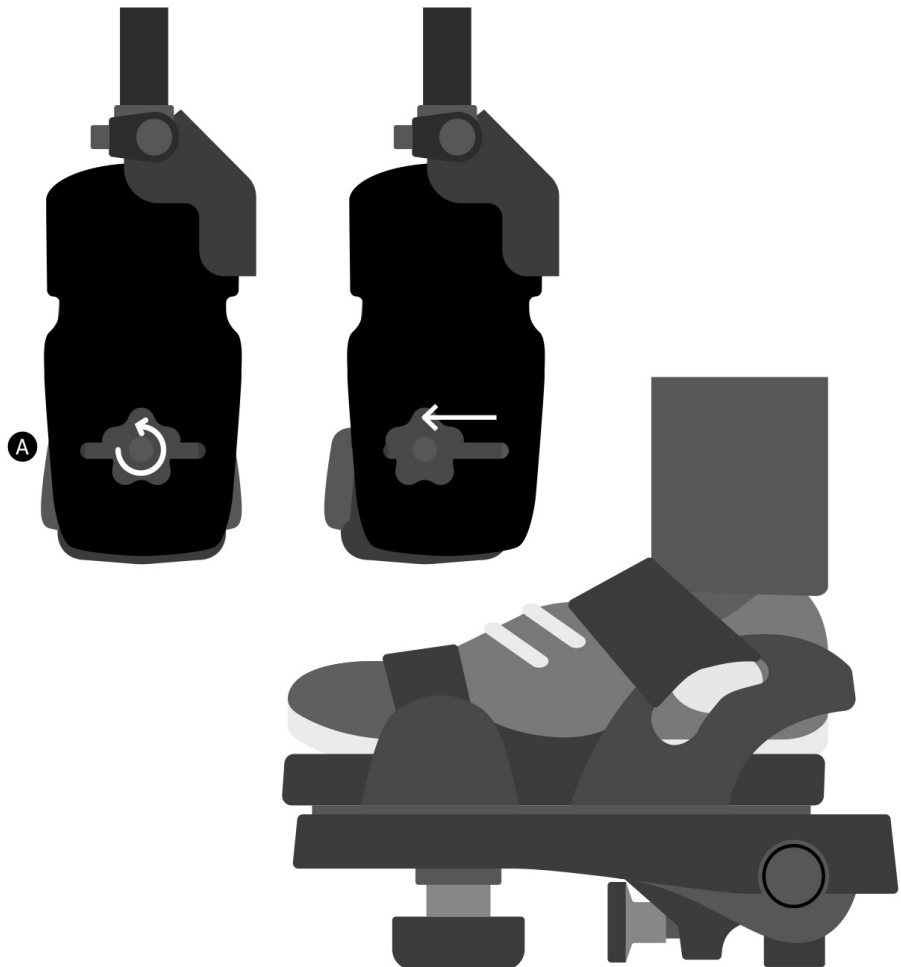

If the child is wearing sandals or light footwear check the straps to make sure the webbing does not irritate the skin.

11.13 Footplate angle adjustment

To set the angle to accommodate plantarflexion and dorsiflexion, simply loosen or tighten the knob **A** to set the desired angle.



11.14 Adjusting for abduction

Loosen levers **A** on each leg support. Adjust leg support to desired angle as displayed on the angle indicator. Re-tighten levers.

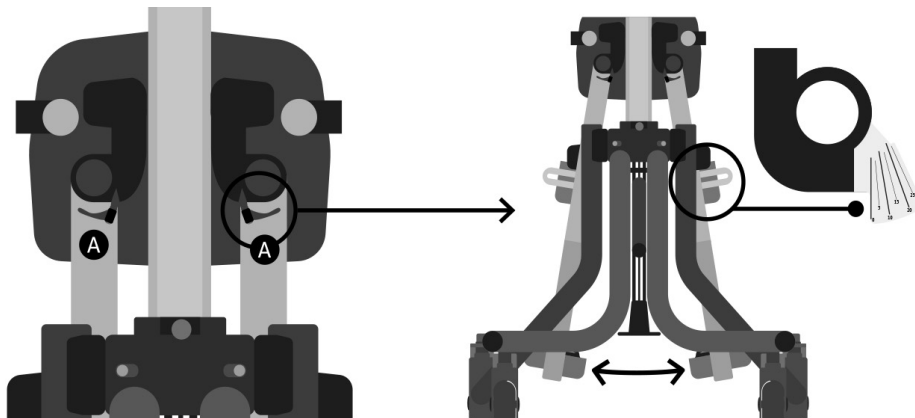

11.15 Product conversion – supine to prone

To convert the Squiggles+ to accommodate prone standing, simply remove the headrest as outlined under “Attaching the Headrest” and attach the tray with the cutout facing the child. Loosen the sandals and turn through 180 degrees. Rotate the handle downwards (see 9.3) and you are ready for prone standing.

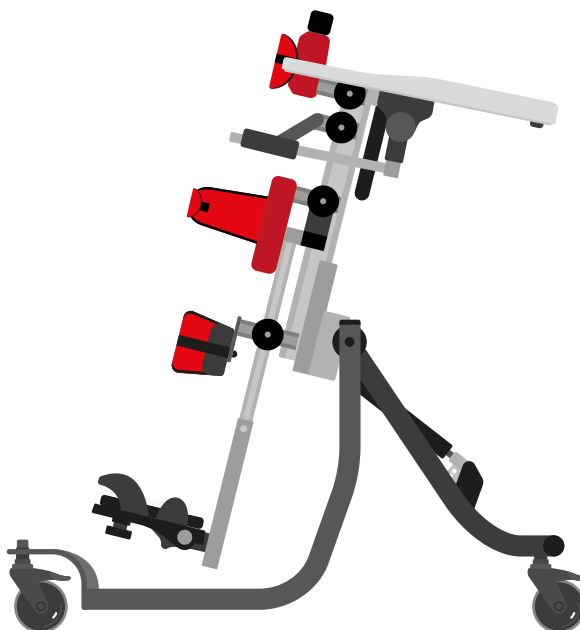

11.16 Product conversion – prone to supine

To convert the Squiggles+ to accommodate supine standing, simply attach the head support as outlined under “Attaching the Headrest” and attach the tray with the cutout facing the child. Loosen the sandals and turn through 180 degrees and you are ready for supine standing.

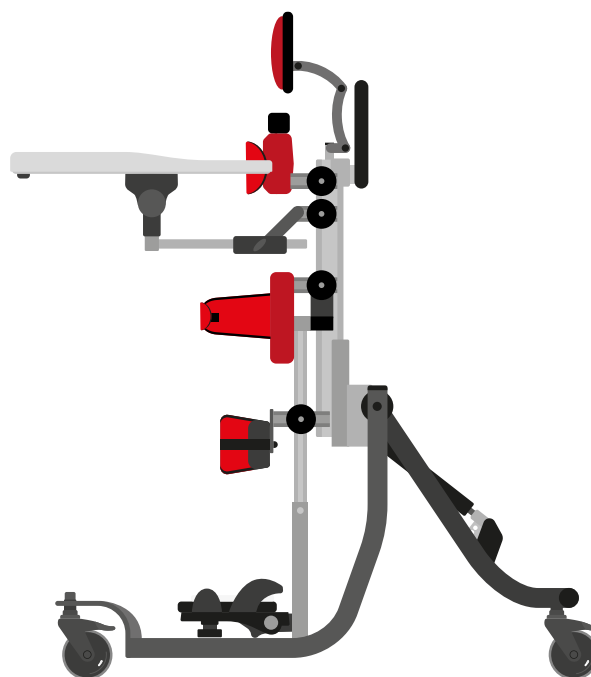

11.17 Adjusting the height of the tray in prone and supine

The height adjustment knobs for the tray are located on either side of the central spine. Loosen the 2 knobs **A**, select the required height and re-tighten.

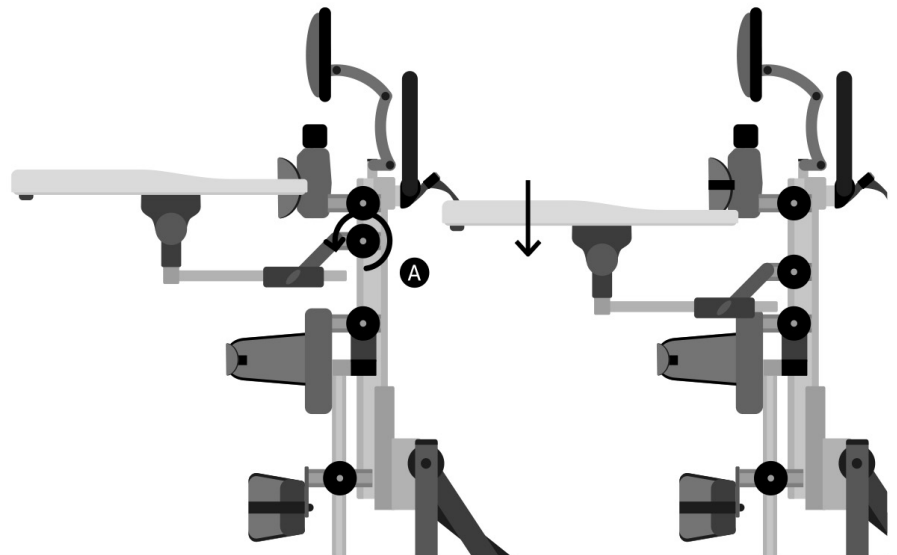

11.18 Adjusting the depth and angle of the tray

Loosen the adjustment knob **A** on either side, slide the tubes along the receiving brackets to achieve the desired depth and re-tighten the knobs. To adjust the angle of the tray loosen the knobs **B** on either side of the tray, set the tray to the required angle and re-tighten securely.

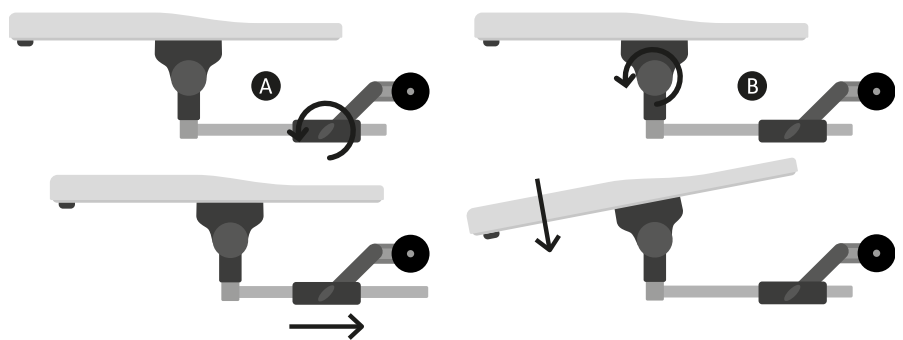

Never use the tray to steer or push the chair.

Do not place hot objects on the tray, greater than 40 degrees Celsius.

Please note that the tray is for the use of the user only. Do not lean or place heavy objects on the tray greater than 8kgs (17.6lbs)

12.0 Frequent adjustment for daily use (therapists/carers/parents)

Parents and carers should be shown how to make frequent adjustments and made aware of the safety checks in section 7 by a technically and clinically competent person who has been trained in the use of the product. Leckey recommend that a written record is maintained of all parent and carers who have been trained in the use of this product.

12.1 Transferring the user into and out of the stander

Before transferring the child into the stander carry out the daily product inspection as outlined in section 14 of this user manual.

Before transferring the child into the product lock all the castors **A**, ensuring that they are facing outwards to maximise product stability. Make sure the straps on the chest, hip support harnesses and sandals are released and out of the way to facilitate transfer.

To facilitate transfer into supine standing, angle the support frame to its most horizontal position. This will enable easier positioning of pads and straps while the child is lying on their back.

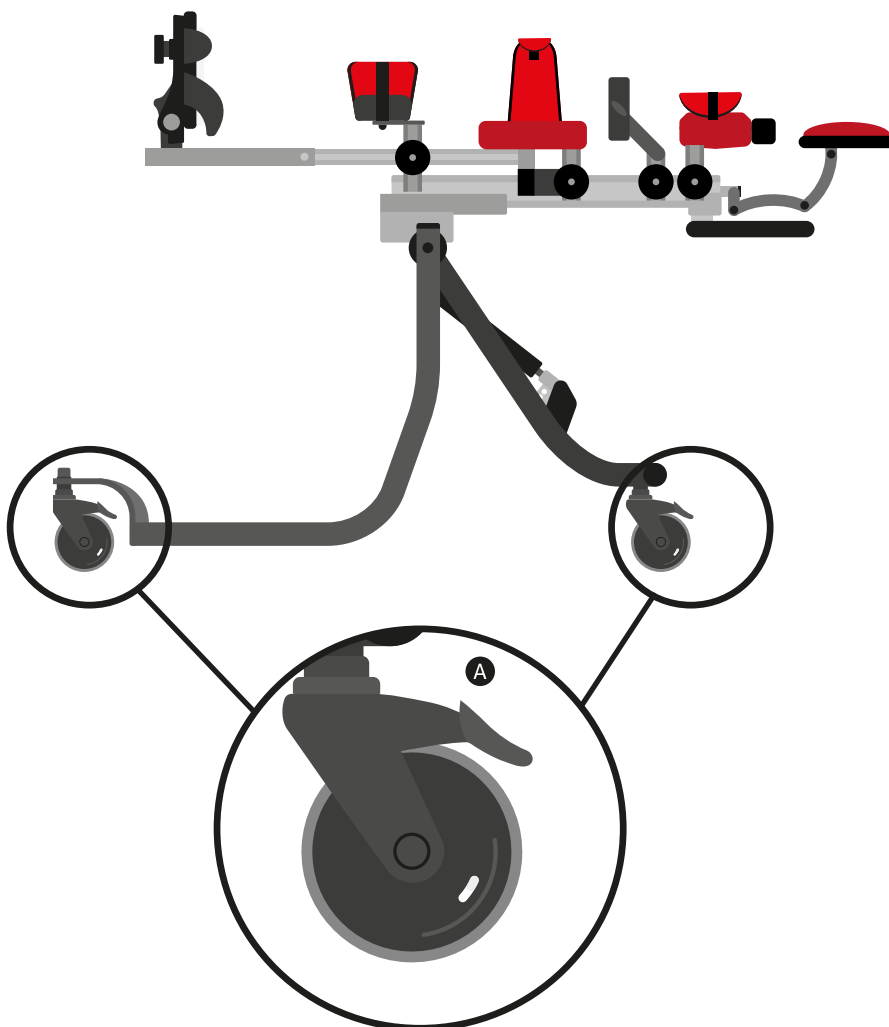

Always secure the hip and chest support harnesses first.

12.2 Chest and hip support harness

To open the chest or hip support harness unclip one buckle and move the harness to one side leaving the other buckle attached. Reverse the process when placing the user back in the product.

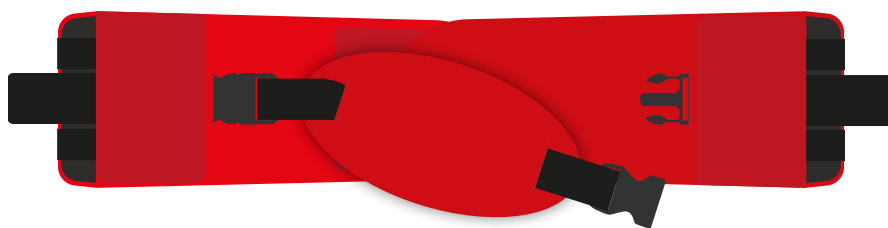

Always secure the chest and hip support harnesses first before making other adjustments.

Always make sure the plastic buckles are fully engaged.

12.3 Sandals

To position the user's feet in the sandals secure the Velcro straps provided so the foot is held in place. The straps should be placed over the bridge of the foot and over the toes. The front strap can be fed through one of two slots on either side of the sandals, depending on the size of the user's feet.



If the child is wearing sandals or light footwear check the straps to make sure the webbing does not irritate the skin.

12.4 Adjusting the height of the tray in prone and supine

The height adjustment knobs for the tray are located on either side of the central spine. Loosen the 2 knobs **A**, select the required height and re-tighten.

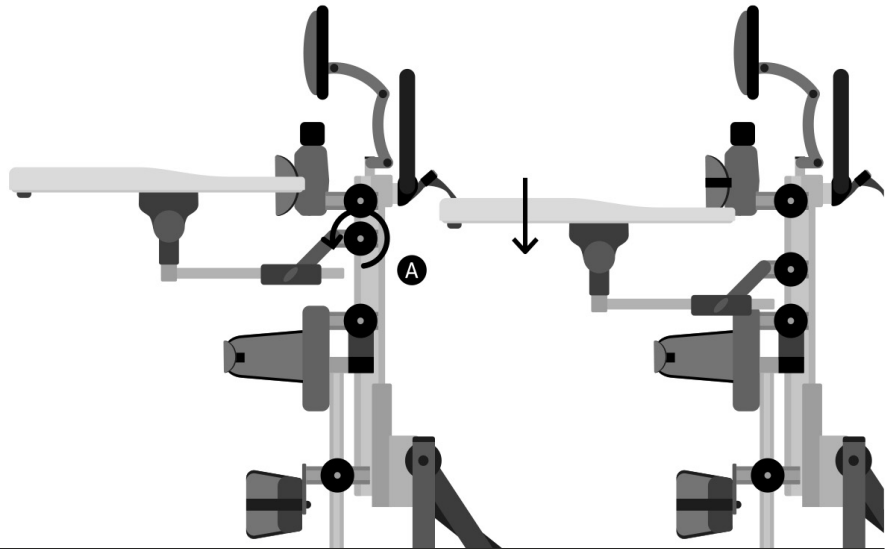

12.5 Adjusting the depth and angle of the tray

Loosen the adjustment knob **A** on either side, slide the tubes along the receiving brackets to achieve the desired depth and re-tighten the knobs. To adjust the angle of the tray loosen the knobs **B** on either side of the tray, set the tray to the required angle and re-tighten securely.

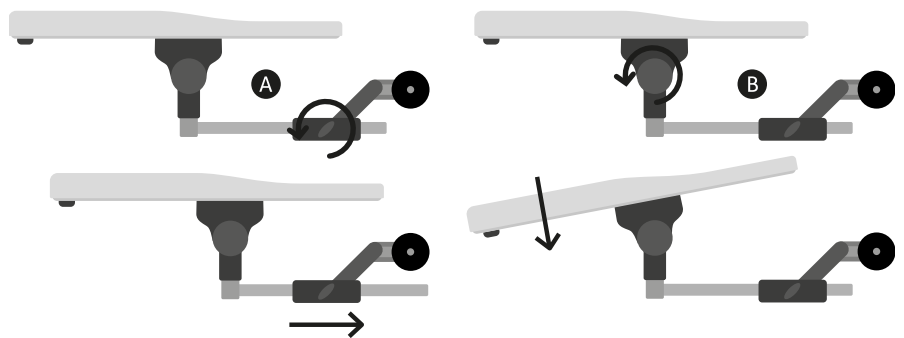

Never use the tray to steer or push the chair.

Do not place hot objects on the tray, greater than 40 degrees Celsius.

Please note that the tray is for the use of the user only. Do not lean or place heavy objects on the tray greater than 8kgs (17.6lbs)

12.6 Grab rail adjustment

To set the depth of the grab rail to suit the child's reach loosening knob **A** adjust to the required depth and then re-tighten.

To set the height of the rail, loosen knob **B** slide the rail to the required height and then re-tighten.

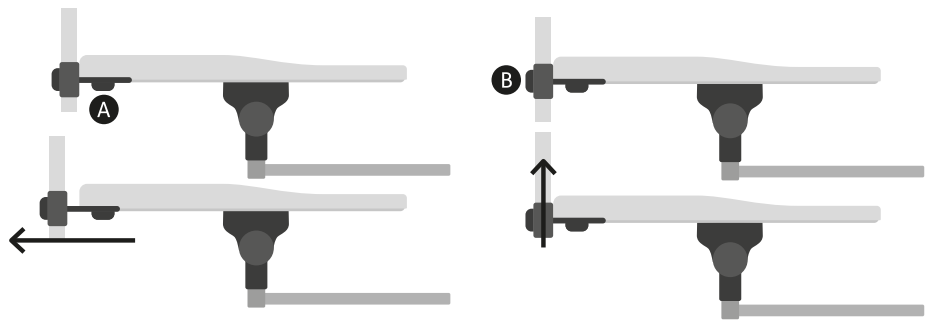

12.7 Pivot chassis angle adjustment

The angle can be adjusted whilst the user is in the stander. You should ensure the child is secured in the stander using the thoracic and hip pads. To adjust the angle of the stander first release the locking pin. To release the pin, pull and rotate plastic knob **A** through 90 degrees into the locked position. **B**

Press the foot pedal **C** down and set the stander to the desired angle using the handle bars. Always re-lock the locking pin **A**. Please note, newer versions of Squiggles+ have a pin that can be entirely pulled out to unlock the chassis, and replaced to re-lock it.

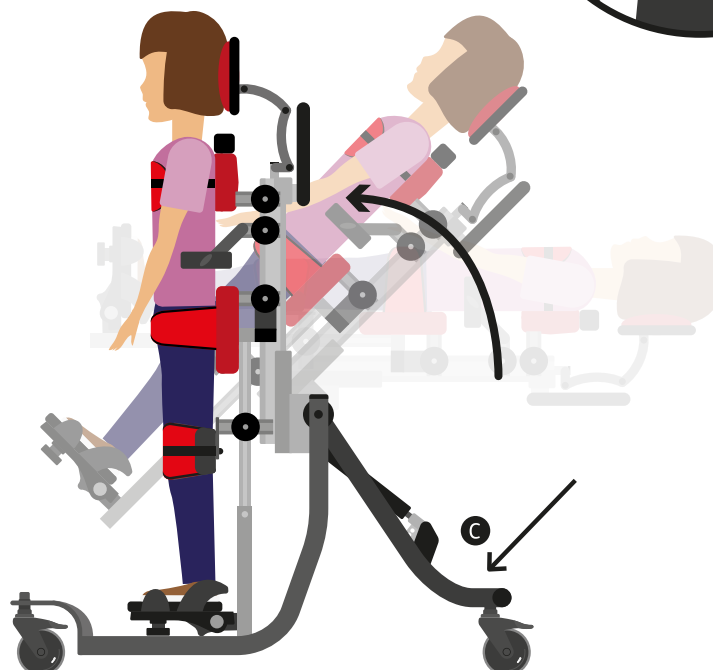
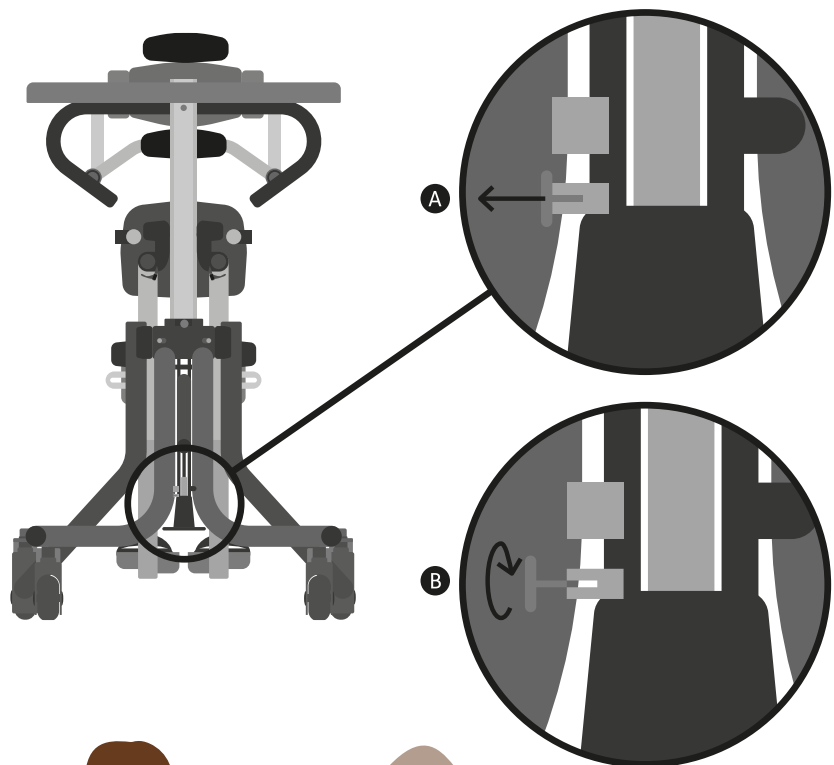

Ensure that the product and user are away from surrounding furnishings to prevent possible collision when adjusting the angle of the pivot chassis.

13.0 Cleaning & Care Information

How to Maintain

When cleaning we recommend that you use only warm water and a non-abrasive detergent. Never use organic solvents or dry cleaning fluids.

Upholstery and fabrics

1. The upholstery and fabrics can be cleaned by hand whilst in place. When cleaning we recommend that you use only warm water and a non-abrasive detergent.
 2. The best cleaning method is a 'wipe & dry' technique.
 3. Staining should be removed as quickly as possible with absorbent cloth, towels or a sponge. Routine soap and warm water sponging is effective for ordinary soiling and minor spills. Be careful not to over wet the fabric as this will cause the staining to spread.
 4. Antiseptic cleaning agents can be used on more stubborn stains. These may require a safe solvent such as Isopropyl Alcohol or Mineral Spirit. A half cup of household bleach to 5 litres of water can also be used as a useful disinfectant.
 5. Always ensure the product is dry before use.
-

Metal and plastic components

1. Soap and water or antibacterial spray can be used for daily cleaning.
2. For deep cleaning a low pressure steam cleaner can be used.
3. Do not use solvents to clean plastic or metal components.
4. Make sure the product is dry before use.

14.0 Daily Product Inspection

Therapists, parents & carers

We recommend that daily visual checks of the equipment are carried out by therapists, carers or parents to ensure the product is safe for use. The recommend daily checks are detailed below.

1. Ensure all adjustment knobs and bolts are in place and secure.

2. Check all upholstery for signs of wear and tear

3. Check all castors are moving freely and lock securely

4. Check all Velcro strips and brush fluff to ensure straps secure firmly.

If in any doubt to the continued safe use of your Leckey product or if any parts should fail, please cease using the product and contact our Customer Care Team or your local dealer as soon as possible.

15.0 Annual Product Inspection

(Therapist, Technician, Product Specialist, Dealer)

Leckey recommend that each product should be subject to a detailed inspection at least once a year and every time the product is reissued for use. This inspection should be carried out by a technically competent person who has been trained in the use of the product and should include the following checks as a minimum requirement.

1. Check all knobs, nuts, bolts and plastic buckles are in place, replacing any missing items. Paying particular attention to the following items; > Headsupport locking bolts > Chest and hip height and angle adjustments > Knee cups adjustment knobs and straps > Footrest angle adjustment

2. Check the chassis folding and angle adjustment mechanism is working properly. Also, check that the locking pin on the Pivot Chassis engages securely in the pedal.

3. Lift the base to check each castor individually. Make sure they are moving freely and remove any dirt from the rubber wheels. Check that the brakes lock the wheels securely.

4. Visually check the structure of the product paying attention to weld points on the frame ensuring there are no signs of fatigue or cracking around the welds.

5. Leckey recommend that a written record is maintained of all annual product inspections.

If in any doubt to the continued safe use of your Leckey product or if any parts should fail, please cease using the product and contact our Customer Care Team or your local dealer as soon as possible.

16.0 Re-issuing Leckey Products

Most Leckey products are assessed and ordered to meet the needs of an individual user. Before reissuing a product we recommend that the therapist prescribing the product has carried out an equipment compatibility check for the new user and has ensured that the product being re-issued contains no modifications or special attachments.

A detailed technical inspection should be carried on the product prior to re-issuing. This should be carried out by a technically competent person who has been trained in the use and inspection of the product. Please refer to **section 15** for the required checks to be carried out.

Before re-issuing a product, we recommend it is disinfected using the following procedure:

Note: Always clean the product first to remove accumulated soiling prior to disinfecting/sanitising

1. Where possible, we recommend the use of an automated “fogger” disinfection system that is used to completely cover the product surfaces with a disinfectant agent. The manufacturer’s instructions for the chosen system should be referred to prior to use and followed exactly.
2. Where an automated disinfection system is not available, all product surfaces should be wiped over with disinfectant surface wipes or liquid disinfectant on a soft cloth. Suitable products are 70% IPA, 70% Alcohol or diluted bleach. The manufacturer’s instructions for the chosen product should be followed. Product upholstery and fabrics should be cleaned thoroughly in accordance with section, Cleaning and Care Information, of this manual.

Ensure a copy of the user manual is supplied with the product. A copy can be downloaded from our website www.leckey.com.

Leckey recommend that a written record is maintained of all product inspections carried out during the reissue of the product.

If in any doubt to the continued safe use of your Leckey product or if any parts should fail, please cease using the product and contact our Customer Care Team or your local dealer as soon as possible.

17.0 Product Servicing

Servicing of all Leckey products should only be carried out by technically competent persons who have been trained in the use of the product.

All international service enquiries should be directed to the appropriate Leckey distributor who will be delighted to assist you. For further information on Leckey distributors please visit our website www.leckey.com.

18.0 Technical Information

Product and Accessory Codes

184-600	Stander support
184-764	Pivot Chassis
184-1800-02	Stander covers – Blue
184-1800-04	Stander covers – Purple
184-1800-09	Stander covers – Red
184-1800-09VIN	Stander covers – Red Vinyl

Accessories

Codes prefixed by an asterisk are available in four colour options.

02	– Blue
04	– Purple
09	– Red
09VIN	– Red Vinyl

152-1600	Size 1 Sandals
152-2600	Size 2 Sandals
118-619	Tray
117-769	Grab Rails
118-697	Headrest Support
*184-1814	Headrest cushion with laterals
118-687	Headrest laterals

Age (approx.)	1-5
Max User Weight	22kg / 48.4lbs
User Height	Min 730mm / 28.5 inches Max 1100mm / 43.3 inches
Chest Support Height (Distance from footplate to armpit)	Min 160mm / 6.25 inches Max 820mm / 32 inches
Chest / Hip Width	Min 160mm / 6.25 inches Max 230mm / 9 inches
Hip Support Height (Distance from footplate to mid-buttock)	Min 300mm / 11.8 inches Max 530mm / 20.8 inches
Distance between mid line of knees	Min 140mm / 5.5 inches Max 215mm / 8.4 inches
Footplate	Plantarflexion 10° Dorsiflexion 10°
Pivot chassis angle range	90-180° 90 - 70°
Tray height - prone	Min 555mm / 21.9 inches Max 825mm / 32.5 inches
Tray height - supine	Min 480mm / 18.5 inches Max 825mm / 32.5 inches
Pivot chassis footprint (Minimum dimensions for storage)	5.5kg / 12.1lbs Width 550mm / 21.7 inches Length 700mm / 27.6 inches Height 300mm / 11.8 inches
Standard support frame (Minimum dimensions for storage)	7kg / 15.4lbs Width 380mm / 15.4 inches Length 890mm / 26.8 inches Height 380mm / 15.4 inches

Table of Symbols























Symbol	Meaning
	Medical Device
	Read the Instructions for Use
	CE mark
	Warning
	Manufacturer
	Product code
	Serial number
	Max occupancy weight
	Date of Manufacture
	For indoor use only
	Latex free
	Unique Device Identification
	Do not machine wash
	Do not dry clean
	Do not bleach
	Do not iron

Table of Symbols

Symbol	Meaning
	Do not tumble dry
	Machine wash- water temperature 40°C
	Dry clean- any solvent except tetrachlorethylene
	Machine wash- water temperature 60°C
	Iron- medium temperature
	Drip dry



USA Distributor

Sunrise Medical (US) LLC
2842 N Business Park Avenue
Fresno, CA 93727

sunrisemedical.com

T: 1-800-333-4000
F: 1-800-300-7502
E: customseating@sunmed.com

Canadian Distributor

Sunrise Medical
237 Romina Drive, Unit 3,
Concord, ON, L4K 4V3

sunrisemedical.ca

T: +1.800.263.3390
F: +1.800.561.5834
E: mkt.canada@sunmed.com

Please visit leckey.com for a full list of Leckey distributors.

James Leckey Design Limited
19 Ballinderry Road
Lisburn, BT28 2SA
Northern Ireland

leckey.com

(+44) 28 9260 0750
hello@leckey.com



LS825-05