

dynamic™ 



SHARK DK-REMD/REMDB Series of Remotes

Installation Manual



GBK80258 Issue 3, July 2010

About this Manual

This manual has been designed to help you install and configure a DYNAMIC CONTROLS (DYNAMIC) SHARK powerchair control system for a 'generic' brand powerchair. It describes the general principle, but it gives no guidelines for specific applications. If there is a specific requirement for your application, please contact DYNAMIC CONTROLS or one of the sales and service agents to assist you.

This manual must be read together with all other relevant SHARK Module manuals, as well as all applicable DYNAMIC Technical Service Bullentins (TSBs), application notes and service instructions.

In this manual, a few symbols will help you identify the purpose of the paragraph that follows:

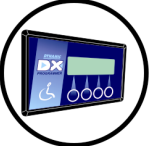
	<p>Notes & Precautions:</p> <p>Notes provide supporting information in order to install, configure, and use the product. Not following the instructions given in notes or precautions can lead to equipment failure.</p>
	<p>Warnings:</p> <p>Warnings provide important information that must be followed in order to install, configure, and use the product safely and efficiently. Not following the instructions given in a warning can potentially lead to equipment failure, damage to surrounding property, injury or death.</p>
	<p>Programming notes:</p> <p>This icon denotes that the paragraph refers to the programming of SHARK.</p>

The term '**programming**' used throughout this manual refers to adjusting parameters and configuring options to suit an application. 'Programming' does not change or alter any software within the controller and is performed using a controlled programming tool available only to authorised personnel.

SHARK is not user serviceable. Specialized tools are necessary for the repair of any SHARK component. Any attempt to gain access to or in any way abuse the electronic components and associated assemblies that make up the powerchair system renders the manufacturer's warranty void and the manufacturer free from liability.

Do not install, maintain or operate this equipment without reading, understanding and following this manual – including the Safety and Misuse Warnings – otherwise injury or damage may result. This manual contains integration, set-up, operating environment, test and maintenance information needed in order to ensure reliable and safe use of the product.

Due to continuous product improvement DYNAMIC reserves the right to update this manual. This manual supersedes all previous issues, which must no longer be used.

DYNAMIC reserves the right to change the product without notification.

DYNAMIC and the DYNAMIC logo are trademarks of DYNAMIC CONTROLS. All other brand and product names, fonts, and company names and logos are trademarks or registered trademarks of their respective companies.

DYNAMIC owns and will retain all trademark rights and DYNAMIC or its licensors own and will retain all copyright, trade secret and other proprietary rights, in and to the documentation.

All materials contained within this manual, in hard-copy or electronic format, are protected by copyright laws and other intellectual property laws.

© Copyright 2010 DYNAMIC CONTROLS, Christchurch, New Zealand. All rights reserved.

Table of contents

1	Introduction to SHARK	5
1.1	The SHARK system	5
1.2	System configurations	6
2	DK-REMD Operation	7
2.1	The Keypad.....	7
2.2	Turning the SHARK on and off.....	8
2.2.1	Out Of Neutral At Power Up (OONAPU).....	8
2.2.2	SHARK Lock.....	9
2.2.3	Sleep Mode	9
2.3	Driving.....	10
2.3.1	The Joystick.....	10
2.3.2	Adjust the maximum drive speed.....	10
2.3.3	The Speedometer.....	11
2.3.4	The Horn	11
2.4	The Battery Gauge	12
2.4.1	Battery charge indication.....	12
2.4.2	Other indications	12
2.5	The Seating Functions (REMD11 & REMD21 only).....	13
2.6	The Lights (REMD21 & REMD31 Only).....	14
2.7	Attendant Mode.....	14
2.8	Battery charging	15
2.9	The Fault Indicator - Flash Codes	16
3	Installation	17
3.1	Specifications	17
3.1.1	Electrical Specifications.....	17
3.1.2	Mechanical Specifications	17
3.2	Mounting.....	18
3.2.1	REMD connection with the Power Module.....	19

4	Programming SHARK	20
4.1	Parameter List / Parameter descriptions	20
4.2	Programming procedure	21
4.2.1	Programming by Dynamic.....	21
4.2.2	Programming by the Powerchair Manufacturer.....	21
4.2.3	Programming by the Dealer	21
5	Testing / Diagnostics	22
5.1	Testing	22
5.2	Diagnostics.....	22
6	Appendices	23
6.1	Accessories + Parts List	23
6.2	Intended Use and Regulatory Statement	24
6.3	Service life	25
6.4	Maintenance.....	25
6.5	Warranty	26
6.6	Safety and Misuse Warnings	26
6.7	Electromagnetic Compatibility (EMC)	27
6.8	Environmental statement	27

1 Introduction to SHARK

The SHARK System is a versatile and cost-effective control solution. The Remote and the Power Module of the SHARK System are separate, so both can be optimized without compromising power, range or drive performance.

- SHARK features DYNAMIC's breakthrough "Chair Tamer" technology, providing unprecedented chair performance, control and safety.
- A number of remotes are available to meet a wide range of user needs. These range from optimally small, highly ergonomic units to units with a more traditional appearance and standard functionality.
- A choice of power modules offers basic 'drive only' functionality up through sophisticated modules supporting multiple seat adjustments, lights, etc.
- No heavy power cables running from the armrest to the motors and batteries.
- No hot surfaces for the user to touch.
- A longer and higher current delivery than equivalently rated integral controllers.
- Superior EMC performance due to minimized power wiring.

1.1 The SHARK system

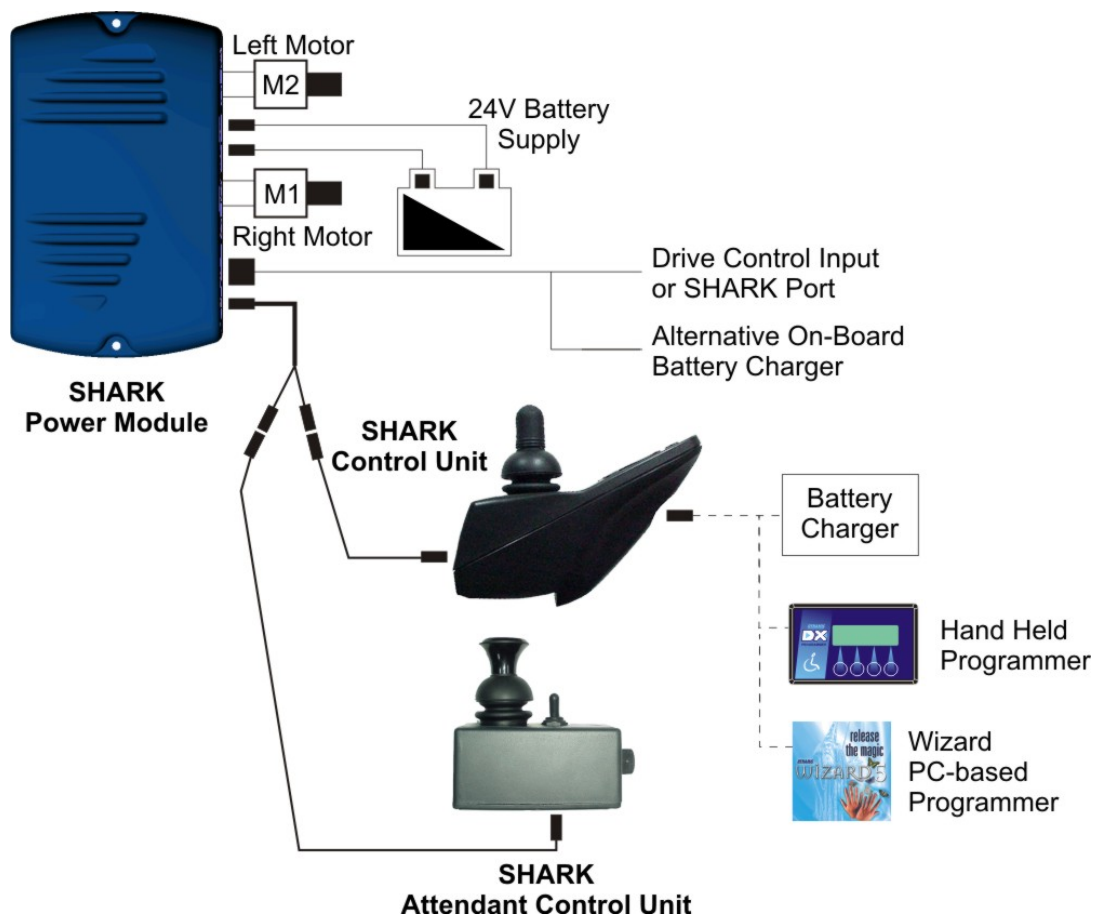

1.2 System configurations

A number of Remotes and Power Modules are available to meet a variety of user needs, from drive-only to multiple seat actuators and lights.

Application	Remote	Suggested Power Module
Drive-only	<p>DK-REMD01 / DK-REMD01B*</p>	<p>DK-PMB40 (40A) DK-PMB50 (50A) DK-PMB60 (60A) DK-PMB01 (75A) DK-PMC01 (90A)</p>
Drive + Actuators	<p>DK-REMD11 / DK-REMD11B*</p>	<p>DK-PMB11 (75A, 1 Actuator) DK-PMB21 (75A, 2 Actuators) DK-PMC21 (90A, 2 Actuators)</p>
Drive + Lights	<p>DK-REMD31 / DK-REMD31B*</p>	<p>DK-PMB31 (75A)</p>
Drive + Actuators + Lights	<p>DK-REMD21 / DK-REMD21B*</p>	<p>DK-PMB21 (75A, 2 Actuators) DK-PMC21 (90A, 2 Actuators)</p>

*All REMDxxB variants have a low-force joystick, a matt keypad finish, a horn volume of at least 75 dB and a programmable audio/visual deep-discharge warning to comply with ISO7176-14 (2008) regulations.

This manual should be read together with the associated power module installation manual. See section 6.1 for a list of Installation Manuals and their part numbers.

2 DK-REMD Operation

2.1 The Keypad

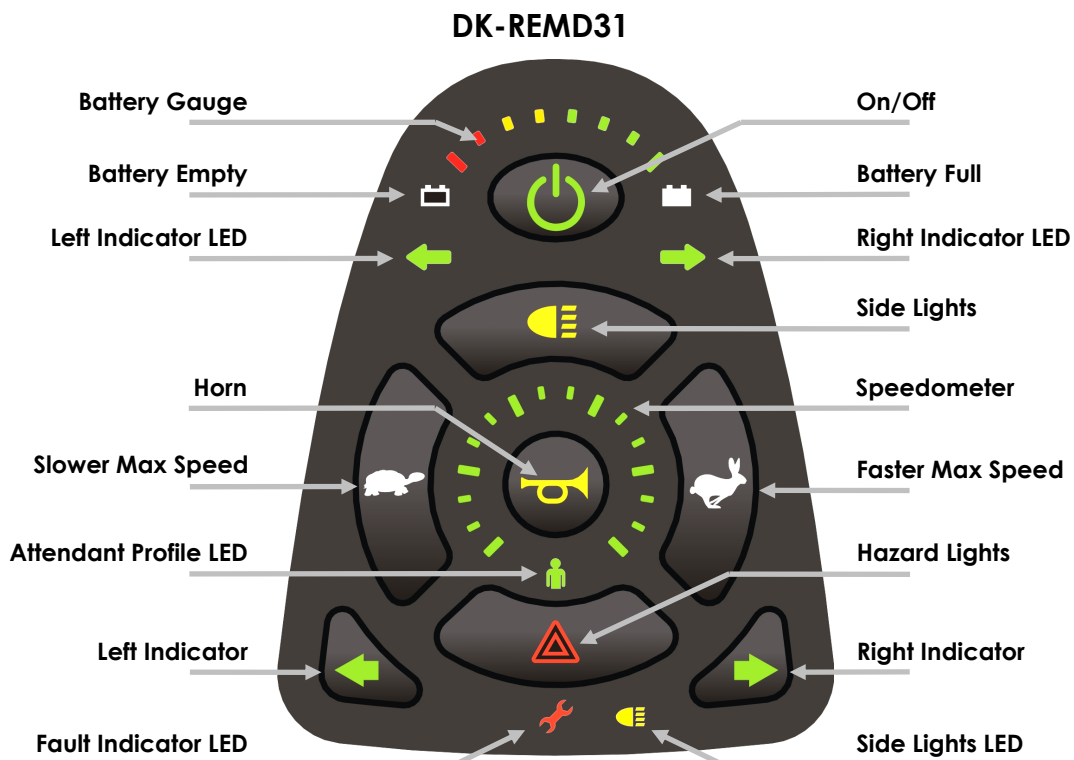
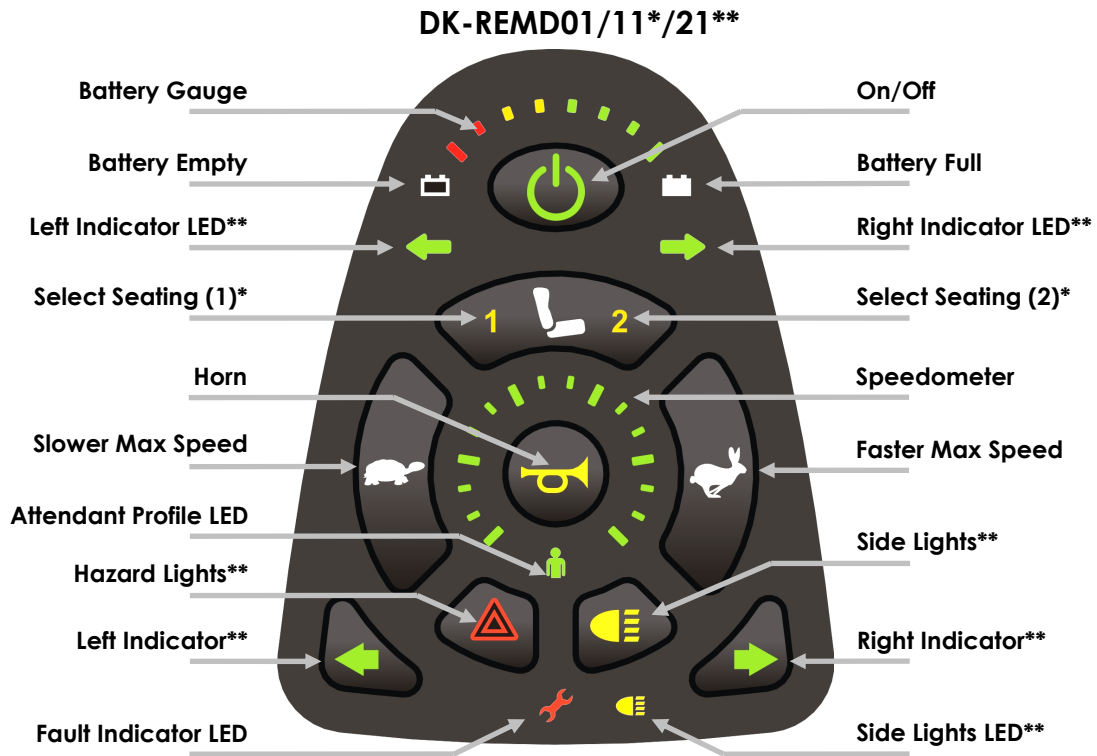

2.2 Turning the SHARK on and off

To turn on the SHARK

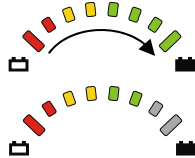

	<p>Press the on/off button.</p> <ul style="list-style-type: none"> • All Battery Gauge LEDs turn on one by one. • After the SHARK has started up successfully, the Battery Gauge shows the charge of the battery. 	
---	---	---

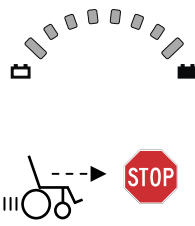
To turn off the SHARK

	<p>Press the on/off button.</p> <ul style="list-style-type: none"> • The SHARK turns off. <p>If the on/off button is pressed while the chair is driving, the chair will perform an emergency stop before it turns off.</p>	
---	---	---

The SHARK will start up in the Drive Program that has been set with the **Active Drive Program** parameter. The SHARK has up to 4 Drive Programs that can be selected only with the Wizard or the HHP. The user cannot select a different Drive Program. Use the different programs for different users, or for different types of chairs.

2.2.1 Out Of Neutral At Power Up (OONAPU)

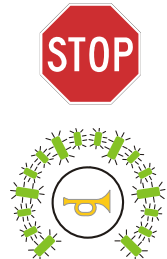
 	<p>If the SHARK is turned on while the joystick is not in the centre position, an “Out Of Neutral At Power Up” fault occurs.</p> <ul style="list-style-type: none"> • During an OONAPU fault the speedometer LEDs flash continuously and the chair will not drive. As soon as the joystick is released back to the centre, the fault goes away and the chair will drive normally. 	
--	--	---

OONAPU is a feature that prevents sudden and unexpected powerchair movements if the joystick is out of the centre when the controller is turned on.

	<p>Warning:</p> <p>If an OONAPU error does not go away after the joystick is released, the SHARK may be damaged. Do not use the powerchair and consult a service agent.</p>
---	--

2.2.2 SHARK Lock



If the **Lock Enable** parameter is set to 'Yes', the SHARK can be locked by pressing the on/off button for more than 4 seconds. Lock the SHARK to prevent unauthorized persons from operating the chair.

To lock the SHARK

<p>> 4 s</p>	<p>Press the on/off button for 4 seconds when the SHARK is turned on.</p> <ul style="list-style-type: none"> The SHARK turns off immediately when the on/off button is pushed. After 4 seconds all LEDs of the battery gauge will flash twice and the horn will give two short beeps, to indicate that the SHARK is now locked. 	<p>2 x</p>
-----------------	---	------------

To unlock the SHARK

	<p>Press the on/off button.</p> <ul style="list-style-type: none"> The SHARK will turn on, and the LEDs of the battery gauge will slowly flash from right to left to indicate that the SHARK is locked. 	
<p>2 x</p>	<p>Press the horn button twice within 10 seconds.</p> <ul style="list-style-type: none"> The SHARK will turn on normally. <p>If the horn button is not pressed within 10 seconds, the SHARK will turn off again.</p>	<p>< 10 s →</p> <p>> 10 s →</p>

2.2.3 Sleep Mode



The SHARK will go to sleep after a period without joystick movement. This period can be set with the **Sleep Timer** parameter.

When the SHARK sleeps, it is partially turned off to reduce energy consumption and to make sure that the powerchair does not move when the user accidentally moves the joystick.

To wake up the SHARK

 	<p>Press the on/off button only*, or press any button on the SHARK or move the joystick**.</p> <ul style="list-style-type: none"> The SHARK turns on. 	
------	--	--



* If the **Wakeup Style** parameter is set to 'Buttons'

If the **Wakeup Style parameter is set to 'Joystick and Buttons'

When a programmer is connected to the SHARK, the SHARK will not go to sleep. If the SHARK goes to sleep during charging, the charging of the battery will continue.

2.3 Driving





2.3.1 The Joystick

	<p>Move the joystick.</p> <ul style="list-style-type: none"> • The powerchair starts to drive in the direction of the joystick movement. • The amount of joystick movement determines the speed of the powerchair. If the joystick is moved further from the centre, the powerchair will drive faster. 	
---	--	---

2.3.2 Adjust the maximum drive speed



You can adjust the maximum speed of the chair to your preference or environment. The currently selected top speed is shown on the Speedometer.

 Slower	<p>Press <u>and release</u> the 'slower' button to decrease the maximum speed of the chair <u>by 20 %</u>. Press <u>and hold</u> the 'slower' button to decrease the maximum speed of the chair <u>in fine steps</u>*.</p>	
 Faster	<p>Press <u>and release</u> the 'faster' button to increase the maximum speed of the chair <u>by 20 %</u>. Press <u>and hold</u> the 'faster' button to increase the maximum speed of the chair <u>in fine steps</u>*.</p>	

*If adjusting the speed in fine steps does not work, simultaneously hold down the 'slower' and 'faster' buttons for 2 seconds to activate fine speed control. The SHARK will beep when the mode has been changed.

Using fine steps can be particularly useful for matching the chair speed to the walking speed of an accompanying pedestrian.

The **Speed Button Sensitivity** parameter sets how quick the maximum speed increments or decrements when a speed button is held down.



Note:

The slowest maximum speed limit is determined by the **Lowest Forward Speed** and **Lowest Turn Speed** parameters.

The fastest maximum speed is determined by the **Maximum Forward Speed**, **Maximum Reverse Speed** and **Maximum Turn Speed** parameters.

2.3.3 The Speedometer



The function of the Speedometer depends on the value of the **Speedo Display** parameter.

Max Speed Only

The speedometer shows the maximum speed that has been set with the speed buttons (see section 2.3.2).



Speedo Plus Max Speed

The speedometer shows the current chair speed together with the maximum speed that has been set with the speed buttons.

When the joystick is deflected and the speed of the chair increases, the LEDs will turn on one by one until the maximum speed (that has been set with the speed buttons) is reached.

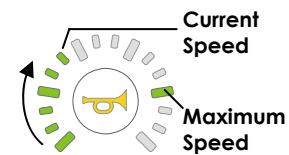

If the bottom-left GREEN LED is flashing, SHARK is in speed limit mode. This happens when the chair is in an unstable position and driving too fast may be dangerous, for example when the seat is raised or tilted. See the Installation Manual of the SHARK Power Module for further details on how to limit the speed when the chair is not stable.



Note:

*If the lowest speed has been selected with the speed buttons, the maximum speed of the chair is limited by the value of **Lowest Forward Speed** and **Lowest Turn Speed**.*

*If the highest speed has been selected with the speed buttons, the maximum speed of the chair is limited by the value of **Maximum Forward Speed**, **Maximum Reverse Speed** and **Maximum Turn Speed**.*

*The Speedometer shows the current chair speed relative to the programmed maximum top speed of the powerchair, as set by **Maximum Forward Speed**.*

2.3.4 The Horn



Press the horn button.

- The horn will sound as long as the button is pressed.



2.4 The Battery Gauge

2.4.1 Battery charge indication

The Battery Gauge indicates how much battery charge remains.

Battery Gauge	Meaning
	Flash Code 2 fault: battery too full. Slow down if you are driving down a slope. Turn on the lights, if fitted.
	Battery full.
	Battery half full. Start the return journey.
	Battery low. Recharge soon.
	Battery almost empty. Recharge now.
	Flash Code 2 fault: battery completely empty. Battery damage will occur if you keep on driving. Recharge immediately.

The remaining battery capacity does not translate directly to remaining physical range of the powerchair. The remaining physical range depends on the ambient temperature, the capacity and age and state of the battery, the driving style of the user and the terrain that the powerchair is being used in. Most of these factors can vary between, or within, one journey.



Note:

If you drive your powerchair until the battery is completely empty or leave the battery with a low charge for a long time, you will damage the battery. This damage is permanent. The battery will never return to its original capacity and your chair will have a shorter range.

2.4.2 Other indications

Apart from the remaining battery charge, the Battery Gauge also indicates the following conditions.

Battery Gauge	Meaning
	Drive Inhibit, the chair will not drive. For example, when a charger is connected to the SHARK. The LEDs turn on one by one from left to right.
	A fault has occurred. All LEDs turn on one by one from left to right to indicate that the chair will not drive. The Fault Indicator LED will show the corresponding Flash Code (see DSM section 9.6).

2.5 The Seating Functions (REMD11 & REMD21 only)





In the Seating Mode the joystick does not drive the chair, it selects and operates the seating functions instead.

Activate the Seating Mode

	<p>Press the Seat Function button to activate Seating Mode.</p> <ul style="list-style-type: none"> The Seating Mode starts with Seat Function 1 selected*. The '1' on the Seat Function button becomes red. 
--	--

Select the Seat Function

	<p>Press the Seat Function button or move the joystick right to select Seat Function 2.</p> 
	<p>Move the joystick left to select Seat Function 1.</p> 

Operate the Seat Function

	<p>Move the joystick forward to operate the Seat Function in one direction.</p>
	<p>Move the joystick in reverse to operate the Seat Function in the opposite direction.</p>
<p>If you move the joystick further away from the centre position, the Seat Function moves faster**.</p>	

Return to the Driving Mode

	<p>Press the Seat Function button until both '1' and '2' are dark to return to Driving Mode.</p> 
--	--

* If Seat Function 1 is enabled. Enable Seat Function 1 by setting the **Seat 1 Current** parameter higher than 2 A.

** If the **Seat Control Type** parameter is set to 'Proportional'









Note:

All joystick navigation and operation requires deflection past the value of the **Joystick Switch Threshold** parameter, except in proportional mode.

2.6 The Lights (REMD21 & REMD31 Only)

To operate the lights

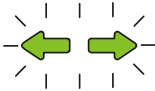
 REMD21  REMD31	<p>Press the side light button to switch the side/positioning lights on or off.</p> <ul style="list-style-type: none"> The side light LED is on when the sidelights are switched on. 	
	<p>Press the indicator buttons to switch the indicators on or off.</p> <ul style="list-style-type: none"> The indicator LEDs flash at the same rate as the indicator lights. <p>The indicators will switch off automatically *.</p>	
 REMD21  REMD31	<p>Press the hazard light button to switch the hazard lights on or off.</p> <ul style="list-style-type: none"> Both indicator LEDs flash together at the same rate as the indicator lights. 	

* If the **Indicator Auto-cancel** parameter does not have the value 'Off'.

2.7 Attendant Mode



Attendant Mode is selected when the User/Attendant switch on the DK-ACU Attendant Control module is set to 'Attendant'. In Attendant Mode, the Attendant Control LED is on.

In Attendant Mode, the joystick of the REMD does not work. Only the joystick on the DK-ACU is operational.

See the DK-ACU Installation Manual for further details.

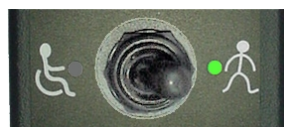

DK-ACU in Attendant Mode

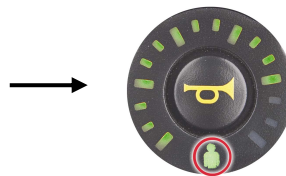

Attendant Control LED is on

2.8 Battery charging

The 3-pin XLR battery charging socket is located on the front of the SHARK. If the chair has an On-board Battery Charger (OBC), plug the OBC power cable into a power outlet.

Charging Socket



The powerchair does not drive when the batteries are being charged. Make sure that the battery charger you use provides a drive inhibit signal before you connect it to the charging socket. If you are not sure, ask your dealer.

When the SHARK is turned on during charging, the LEDs of the battery gauge will swap between showing the approximate battery charge, and turning on one by one from left to right to indicate that the powerchair will not drive.

When the Battery Charger shows a 'full' battery charge, you can remove the charger connector from the SHARK. Do not use the indication on the battery gauge. Only use the indication on the battery charger itself to see when charging is complete.



Notes:

1. It is recommended to leave the SHARK off while charging when possible. A load during charging (for example, the use of seating functions) causes a temporary voltage drop in the battery. This causes some battery chargers to think that the battery is still empty while it is actually fully charged. Depending on the specifications of the battery charger, this can result in overcharging and possible battery damage. Read the manual of your battery charger for more information.
2. Overcharging dramatically decreases the lifespan of a battery.
3. If SHARK is turned off or goes into sleep mode while charging, charging will continue.



Warnings:

1. Do not disconnect the batteries or open the circuit breaker during charging. See the manual of the battery charger for more information.
2. To remove the charger cable, pull on the plug. Do not pull on the cable. Remove the plug in the direction of the cable, do not try to turn the plug.
3. Select and adjust the battery charger according to the instructions of the battery manufacturer. Failure to do so can damage or destroy the batteries, give poor driving range, or be potentially dangerous.

Drive Inhibit configuration



The Drive Inhibit signal makes sure that the powerchair does not drive when the batteries are being charged. This signal must be provided within the battery charger connector as a connection between pin 2 and pin 3.

2.9 The Fault Indicator - Flash Codes

If a fault condition exists, the Fault Indicator LED shows a Flash Code. A flash code is a specific number of short flashes, followed by a pause.



If the fault is a serious fault that prevents the chair from driving, additionally the Battery Gauge shows a 'Drive Inhibit' indication (see section 2.4.2).



Flash Code	Fault source	Meaning
1	Route / Temperature	<p>The motor current has been at the maximum value for too long.</p> <ul style="list-style-type: none"> The motors may not be strong enough for the chosen route (the route is too steep). <ul style="list-style-type: none"> Turn off the SHARK, let it cool down, then turn it back on again and choose another route. The wheels may be rubbing on the frame. <ul style="list-style-type: none"> Make sure that the wheels can turn freely. The motors may be faulty. <ul style="list-style-type: none"> Have the motor(s) checked by a service technician. <p>The SHARK Power Module is too hot.</p> <ul style="list-style-type: none"> Wait a few minutes and try again If this happens often, contact DYNAMIC
2	Battery	<p>The battery voltage is too low or too high.</p> <ul style="list-style-type: none"> Check the batteries and the cables. Batteries may be empty: charge the batteries. Batteries may be overcharged: <ul style="list-style-type: none"> if driving downhill, slow down or turn on the lights, if fitted. Batteries may be damaged: contact your dealer. <p>If this fault occurs during battery charging, the battery charger is defective or not adjusted correctly.</p> <ul style="list-style-type: none"> Contact your dealer <p>If this fault occurs during when you stop or when you travel down a slope, and the batteries are not full, the battery connector may make intermittent contact.</p> <ul style="list-style-type: none"> Check the battery cables and connectors.
3	Motor 1 (usually left)	<p>The motor is not connected to the SHARK, or there is a short-circuit in the motor connection.</p> <ul style="list-style-type: none"> The motor brushes may have lost connection. Turn the wheels of the chair to reconnect the motor brushes, and then turn the SHARK off and on. If this happens often, the motors may be faulty. Check that the motor cables are not loose or damaged. Contact your dealer.
4	Motor 2 (usually right)	
5	Parkbrake 1 (usually left)	<p>The parkbrake has been released manually.</p> <ul style="list-style-type: none"> Enable the parkbrake, and then turn the SHARK off and on. <p>The parkbrake is not connected to the SHARK, or there is a short-circuit in the parkbrake connection.</p> <ul style="list-style-type: none"> Check that the motor cables are not loose or damaged. Contact your dealer.
6	Parkbrake 2 Right	
9	Missing Power Module	<p>A communication error between the Remote and the Power Module.</p> <ul style="list-style-type: none"> Batteries may be completely empty: charge the batteries. Batteries may be damaged: contact your dealer. Check that the SHARK Bus cable is not loose or damaged. Contact your dealer.
All Other	Internal fault	<ul style="list-style-type: none"> Contact your dealer.

These flash code descriptions are aimed at end users. For a more detailed flash code description see the installation manual of the SHARK Power Module.

3 Installation

3.1 Specifications

3.1.1 Electrical Specifications

Parameter	Value
Operating voltage range	18V – 32V DC (nom. 24V)
Charger rating	max 12A RMS Continuous, limited by SHARK BUS rating
Quiescent Current	< 0.25mA Off, typically 200mA On

3.1.2 Mechanical Specifications

Parameter	Value			
Material	Injection-moulded plastic			
Protection Rating	IPx4			
Shipping Weight	400 g (excluding packing material)			
	Min	Nominal	Max	Units
Force required to operate joystick DK-REMDxx DK-REMDxxB			7.8 2.2	N N
Force required to operate buttons DK-REMDxx DK-REMDxxB	1 1		3 3	N N
Tube mount diameter	15 (5/8)	19 (3/4)	22 (7/8)	mm (in)
Operating Temperature Range	-25 (-13)		50 (122)	°C (°F)
Operating Temperature Range – SHARK Programming Adaptor	0 (32)		50 (122)	°C (°F)
Storage Temperature Range	-40 (-40)		65 (149)	°C (°F)
Operating Humidity Range	0		90	%RH

3.2 Mounting

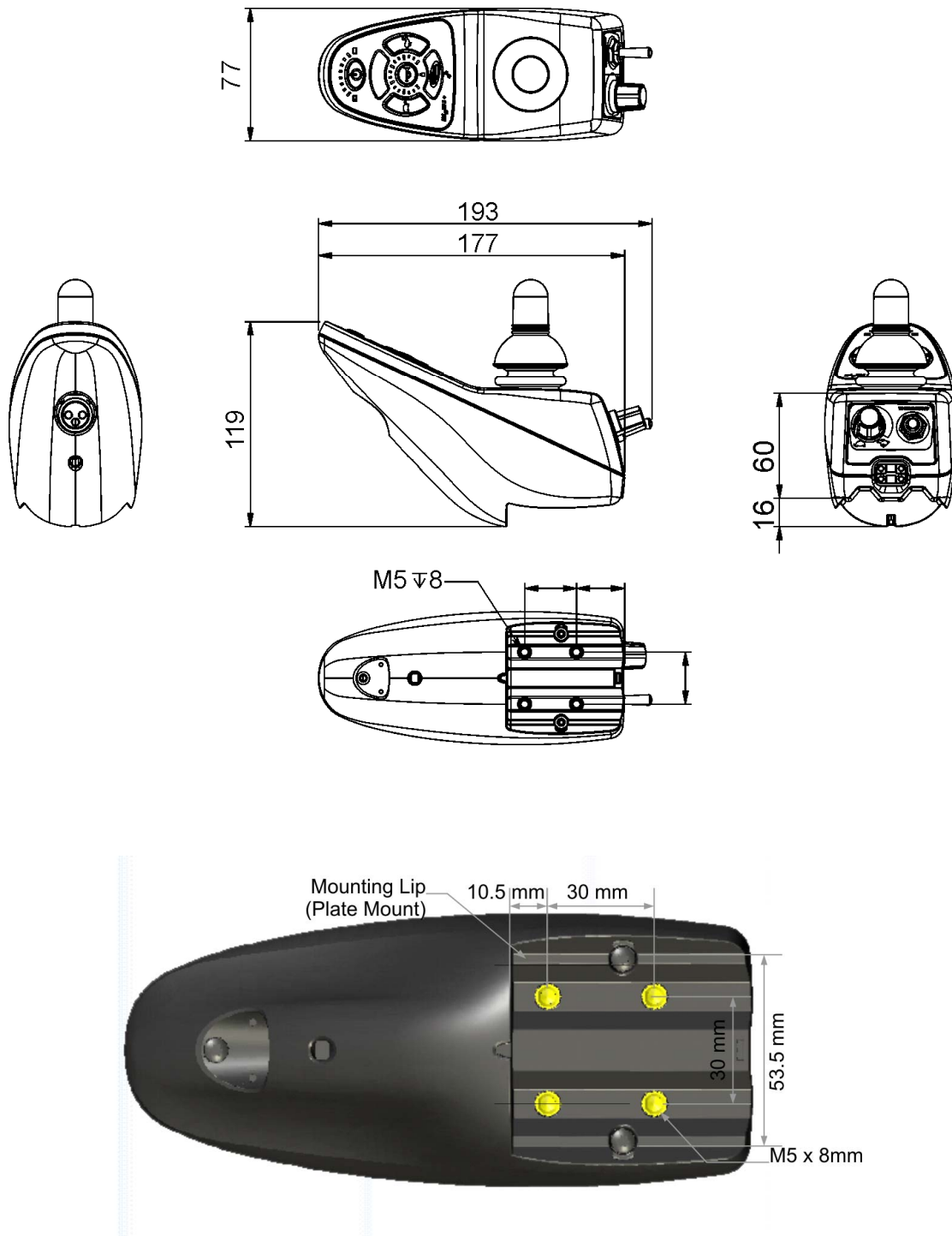

The SHARK Remote can be mounted on either side of the wheelchair, using M5 screws. These should be tightened to a torque of approximately 3 Nm (27 lbf in).

There are three mounting options available: plate mount and left or right tube mount.

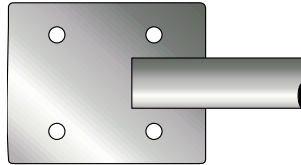
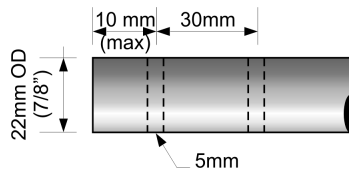

Plate Mount

The SHARK Remote can be mounted using a flat plate, typically welded to a tubular arm. The mounting area on the Remote has support through the center, along with lips to support the outside of the bracket.



Tube Mount

The SHARK Remote can also be mounted using a tube with an outside diameter of 22mm (7/8"). The tube can be mounted in either the left or right mounting channel.

For safe installation of any of the mounting options, select a screw length that protrudes between 4mm and 6mm into the case.

3.2.1 REMD connection with the Power Module

The SHARK BUS connector socket is located at the back of the REMD. The REMD uses a modular 'keyed' connector that can only be plugged in one way – the Remote symbol on top of the plug must be facing up.

Standard length bus cables include:

- 1.5 m (GSM80233)
- 1.0 m (GSM80234)
- 0.5 m (GSM80236).



4 Programming SHARK



Warning:

Performance adjustments should only be made by professionals in the health care field or by persons fully conversant with the adjustment process and the operator's capabilities.

Incorrect settings, or programming in an unsafe location, could cause injury to the operator or bystanders, or damage to the vehicle or surrounding property.

After the vehicle has been configured, check to make sure the vehicle performs to the specifications entered in the programming procedure. If the vehicle does not perform to specifications, reprogram it. Repeat this procedure until the vehicle performs to specifications. If the intended operation cannot be achieved, contact your service agent.

Ensure that deceleration parameters are always higher than acceleration parameters for a safe response.

It is the health care professionals responsibility to ensure that the user is capable both cognitively and physically of understanding and operating the features and functions.

With inappropriate programming settings, certain features and options may not be accessible or perform as expected.

The SHARK is fully programmable to provide superb performance for a wide variety of powerchair configurations and users. All programmed values are stored in the Power Module. In the event that the Remote is replaced, there is no need to reprogram SHARK.

The XLR programming / charger socket is located at the front of the SHARK. To use this socket with the HHP, a DK-ADAPT adaptor plug is needed. To use this socket with the Wizard, either a DK-ADAPT or a DWIZ-ADAPT is needed.

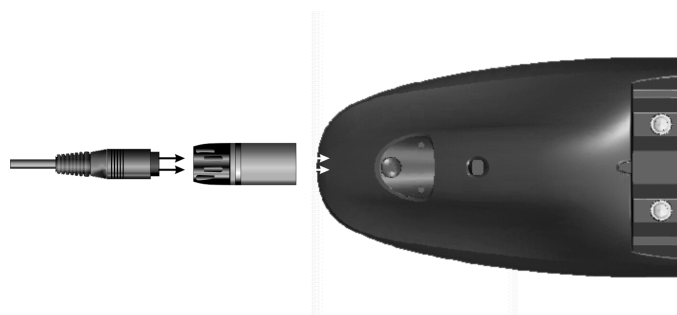

4.1 Parameter List / Parameter descriptions

For a complete list of all parameters and their descriptions, see the 'Programming' section of the installation manual of the SHARK Power Module.

4.2 Programming procedure

SHARK can be programmed at three points:

4.2.1 Programming by Dynamic

Dynamic supplies SHARK pre-configured with a 'sensible' generic program. Customization will be required for specific powerchair and user requirements.

4.2.2 Programming by the Powerchair Manufacturer

The powerchair manufacturer 'tunes' the generic program to suit the characteristics of their particular powerchair. The recommended tool for this is the PC-based Wizard. The programming cable requires a special adaptor to allow it to plug into SHARK.

4.2.3 Programming by the Dealer

The primary task of the dealer is to tune the Drive Program that the powerchair manufacturer has set-up for the specific needs and preferences of the powerchair user.

Programming is typically done using a hand held programmer, a portable programming tool suited to the quick customization of a chair. Simply plug the cable into the charging socket (via the programming adaptor – DK-ADAPT) at the front of the SHARK Remote.

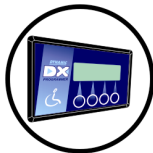

The powerchair manufacturer can limit hand held programmer access to SHARK settings using the PC-based Wizard.

5 Testing / Diagnostics

5.1 Testing

To ensure that the powerchair meets a minimum level of safety, test the powerchair according to the testing procedure that is described in the 'Testing' chapter of installation manual of the SHARK Power Module.

5.2 Diagnostics

See the 'Diagnostics' chapter of the installation manual of the Shark Power Module for diagnostics information such as flash codes.

6 Appendices

6.1 Accessories + Parts List

Dynamic SHARK Installation Manuals		
Part Description	DCL Part #	Qty/Unit
Dynamic SHARK DK-PM(x) Installation Manual	GBK80262	1
Dynamic SHARK DK-REMA Installation Manual	GBK80260	1
Dynamic SHARK DK-REMB Installation Manual	GBK80261	1
Dynamic SHARK DK-REMD/REMDB Installation Manual (This Manual)	GBK80258	1
Dynamic SHARK DK-ACU Installation Manual	GBK80257	1



For a complete list of programming and wiring information for the SHARK system, see the Power Module Installation Manual (GSM80262).

6.2 Intended Use and Regulatory Statement

Intended Use

The Shark Remote and Power Module are intended to provide speed and direction control for small or medium sized power wheelchair systems utilizing dual DC motors and integrated park-brakes. The controller may also operate up to two actuators (for example, seat lift and tilt) and lighting. The intended power source is a 24V battery. The SHARK controller will respond to user input demand via the joystick input, in terms of speed and direction.

The powerchair manufacturers are provided with all the integration, set-up, operating environment, test and maintenance information needed in order to ensure reliable and safe use of the controller.

Device Classification

Europe

The SHARK Controller is a component of a Class I medical device as detailed in the Council Directive 2007/47/EEC concerning Medical Devices.

USA

The SHARK Controller is a component of a Class II medical device (Powered Wheelchair) as detailed in 21 CFR § 890.3860.

Wheelchair Components are classified under 21 CFR § 890.3920 as Product Code KNN, Class I (General Controls), 510(k) exempt.

Compliance and Conformance with Standards

In accordance with the device classification, the SHARK powerchair controller has been designed to enable the powerchair manufacturer to comply with the relevant requirements of the European Medical Device Directive 2007/47/EEC and QSR 21 CFR § 820.

The SHARK Controller has been designed such that the combination of the wheelchair and the SHARK Controller, along with accessories as applicable, complies with the Essential Requirements of the MDD by adopting relevant clauses of harmonised standards EN12184 and EN12182 and the FDA Consensus standard ANSI/RESNA 7176 for performance.

However, final compliance of the complete powerchair system with international and national standards is the responsibility of the powerchair manufacturer or installer.

SHARK Programming Adaptor

The Shark programming adaptor is intended to allow the Shark Controller series of power wheelchair controllers to communicate with the DX Hand Held Programmer (DX-HHP) and the Wizard. The adaptor is not intended to alter the controller in any way, but simply passes information to and from the controller. The information passed may alter the controller performance.

The intended power source is a 24 V battery supply via the charger connector of the Shark controller. The intended environment is indoors, or outdoors in dry conditions.

6.3 Service life

If the product has been installed, used and maintained as recommended, all instructions contained in this manual have been properly followed, and the unit has not been abused, the expected service life period (i.e. serviceable life expectancy) of the product is five (5) years. After this period, DYNAMIC CONTROLS recommends the product be replaced for safety reasons. DYNAMIC CONTROLS accepts no responsibility or liability for product failure if the product is retained in use beyond the stated service life period.

6.4 Maintenance

1. Keep all DYNAMIC CONTROLS products free of dust, dirt and liquids. To clean the product, use a cloth dampened with warm soapy water. Do not use chemicals, solvents or abrasive cleaners, as this may damage the product.
2. Monthly check the joystick gaiter for punctures and wear that might allow dirt or small objects to enter into the remote. If a gaiter is damaged, have the joystick replaced by a competent service technician.
3. Monthly check all vehicle components for loose, damaged or corroded components, such as connectors, terminals, or cables. Restrain all cables to protect them from damage. Replace damaged components.
4. Once every 6 months, test all switchable functions on the DYNAMIC CONTROLS electronics system to ensure they function correctly.
5. There are no user-serviceable parts in any DYNAMIC CONTROLS electronic product. Do not attempt to open any case or undertake any repairs, else warranty will be voided and the safety of the system may be compromised.
6. Where any doubt exists, consult your nearest service centre or agent.



Warning:

It is the responsibility of the end user to maintain the product in a state of good repair at all times. Prolonged exposure to direct sunlight or certain solvents or household chemicals may cause damage to plastic components, resulting in loss of functionality or deterioration in performance.

If any component is damaged in any way, or if internal damage may have occurred (for example by being dropped), have it checked by qualified personnel before operating.

6.5 Warranty

All equipment supplied by DYNAMIC CONTROLS is warranted by the company to be free from faulty workmanship or materials. If any defect is found within the warranty period, the company will repair, or at its discretion replace, the equipment without charge for materials or labour.

This warranty is subject to the provisions that the equipment:

- has been correctly installed
- has been thoroughly checked upon completion of installation, and all programmable options correctly adjusted for safe operation prior to use
- has been used solely in accordance with this manual and all other manuals of the DYNAMIC CONTROLS products that are used on the mobility vehicle
- has been properly connected to a suitable power supply in accordance with this manual
- has not been subjected to misuse or accident, or been modified or repaired by any unauthorised personnel
- has not been connected to third party devices without the specific approval of DYNAMIC CONTROLS
- has been used solely for the driving of electrically powered mobility vehicles in accordance with the intended use and the recommendations of the vehicle manufacturer

6.6 Safety and Misuse Warnings

The DK-REMD/REMDB must be connected to a DK-PMx Power Module to form the Shark control system. All safety and misuse warnings that apply to the Shark System are present in the Installation Manual of the Shark Power Module. Please refer to the installation manual of the Shark Power Module for all applicable safety and misuse warnings.

6.7 Electromagnetic Compatibility (EMC)

DYNAMIC CONTROLS Electronic controllers and accessories have been tested on typical vehicles to confirm compliance with the following appropriate EMC standards:

USA: ANSI/RESNA WC/Vol:2 - 1998 Sec 21

Europe: EN12184: 1999 Sec 9.8.1-3 / ISO7176-21

National and international directives require confirmation of compliance on particular vehicles. Since EMC is dependent on a particular installation, each variation must be tested.

Minimising emissions

To minimise emissions and to maximise the immunity to radiated fields and ESD, follow the 'General Wiring Notes and Recommendations' in section 3.3.1 of the SHARK Power Module Installation Manual.

6.8 Environmental statement

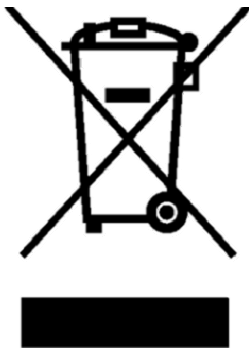

This product has been supplied from an environmentally aware manufacturer.

Please be environmentally responsible and recycle this product at the end of its life through your local recycling facility.

This product may contain substances that could be harmful to the environment if disposed of into a landfill.

Do not dispose of this product in fire.

EUROPE

Ph: +44-1562-826-600

Fax: +44-1562-824-694

eusales@dynamiccontrols.com

ASIA

Ph: +886-955-335-243

Fax: +886 225-981-562

asiasales@dynamiccontrols.com

AUSTRALASIA (CORPORATE OFFICE)

Ph: +64-3-962-2519

Fax: +64-3-962-2966

sales@dynamiccontrols.com

USA

Ph: +1-440-979-0657

Fax: +1-440-979-1028

usasales@dynamiccontrols.com



Dynamic Controls is the world's leading manufacturer of electronic controls for power wheelchairs and scooters.
DYNAMIC was established in 1972 and is headquartered in New Zealand.
Regional centres are located in Europe, United States, Asia, and Australasia.

ISO 13485 certified –

DYNAMIC goes above and beyond industry standard expectations to ensure customers receive the best products possible.