



PRODUCT CATALOG 2018

CLINICALLY SOUND, INNOVATIVE DESIGN AND EXCEPTIONAL VALUE

SPECIALTOMATO.COM

Our Products



Hi-Low Seating

Hi-Low MPS 2 ***

Multi-Positioning Seat Systems

MPS 4 ***

MPS Accessories 5 ***

Customize your Size 6 ***

MPS Car Seat 8 ** (Car seat not available in NZ)



Soft-Touch® Sitters

Sitter with Stationary Base 10 **

Sitter with Mobile Base 10 **

Floor Sitter 10 **

Sitter Only 12 *

Seating Solutions

Mobile Activity Tray 14 *

Liners 16 *

Portable Potty Seat 18 *



Soft-Touch® Therapy Products

Therapy Wedges 19 **

Therapy Rolls 19 **

Push Chairs

EIO 20 **

Jogger 22 **

Measurement Help 24

Brand Story 25



Positioning Support Levels

- * For children with **minimal** positioning needs:
Child can sit on the floor independently, may have mild physical delays, displays good head and trunk control.
- ** For children with **minimal to mild** positioning needs:
Child has some limited sitting balance, displays some independent control of head and trunk, has minimal restrictions of hip and knee range of motion, presents no significant issues with muscle tone (low or high).
- *** For children with **mild to moderate** positioning needs:
Child requires support for sitting, muscle tone effects independent positioning (low or high), displays some control of head and trunk with support, child benefits from tilted position.





Soft-Touch® Material

The Soft-Touch® material outer skin prevents the products from peeling or tearing and also prevents liquids from penetrating the core. It is cool and smooth reducing the possibility of children's skin sticking to the seating surface. The soft-to-the-touch inner core is a specially formulated foam that allows for children to sit comfortably for longer periods of time.



Safety Concern

With over 35 years of manufacturing pediatric seating and positioning systems, our products are safe and easy to use while providing a latex-free contact surface. The contoured designs of our products provide a large surface area for distributing pressure which reduces the risk of skin shear and breakdown. Many of our products are crash-tested for auto and FAA approved for airline use.



Design and Function

Hand-crafted in upstate New York, the Special Tomato® products are designed with the needs of the user and care provider in mind. The superior Soft-Touch® materials are very durable and easy to clean. Our unique bent wooden bases deliver support and strength while the Soft-Touch® material allows our designers to subtly integrate the positioning contours needed for a proper seating system. We stand behind the quality of our products by offering up to a 5 year warranty on most of our products.



Sales and Support

Special Tomato® products are distributed directly by Bergeron Health Care through rehab equipment distributors, schools and health care facilities around the world. Direct field support for samples and in-service information is available across the USA, Canada and across Europe. Please visit our website at www.specialtomato.com to find a distributor or representative near you.

Hi-Low (MPS) Seating System

Height Adjustable Seating with Built-in Growth

NOW... More seat cushion choices from Early Intervention to Adult!

- Affordable Customized Seating
- Tilt-in-Space with Child in Seat
- Floor to Table Height Adjustment
- Contoured Cushion Support
- Tool Free Adjustments
- Ergo Harness Design
- Soft-Touch® Material Latex-Free

5 year warranty

See page 7 for warranty details



Optional Angle Adjustable Tray Shown

Easy lock 3" swivel casters.



-30° to 10° range of tilt-in-space.



30° of hip-flex adjustment.



Optional adjustable tray.



Floor to table height.

Features & Accessories



1 Ergonomic Push Handle
Comfortable grip for all heights.

2 Wood Accents
Added structure with a modern design.

3 Tilt-in-Space
-30° to 5° range of tilt adjustment with child in seat.

4 Tool Free
Height adjustment of all cushions.

5 Footrest Angle, Depth and Height Adjustment
Allows for optimal positioning.

6 Swivel Locking Casters
All 4 easy lock 3" swivel casters for safety and control.

7 MPS Tray
79060159 Dark Gray, Small
79060359 Dark Gray, Large
Sold separately.

8 Hi-Low Adjustment
Raise and lower with child in seat.

9 Colorful Contoured Comfort
Vibrant color choices and many cushion sizes available.

Multi-Positioning Seat (MPS) 5 year warranty

Versatile Seating with Built-in Growth

NEW Cushion sizes available for both Small and Large MPS!
Cushions grow the seating system from 9 months to young adult!

- Adjustable 5-point harness
- Hip-Flex® Seat Cushion
- Height adjustable Trunk and Head Cushions

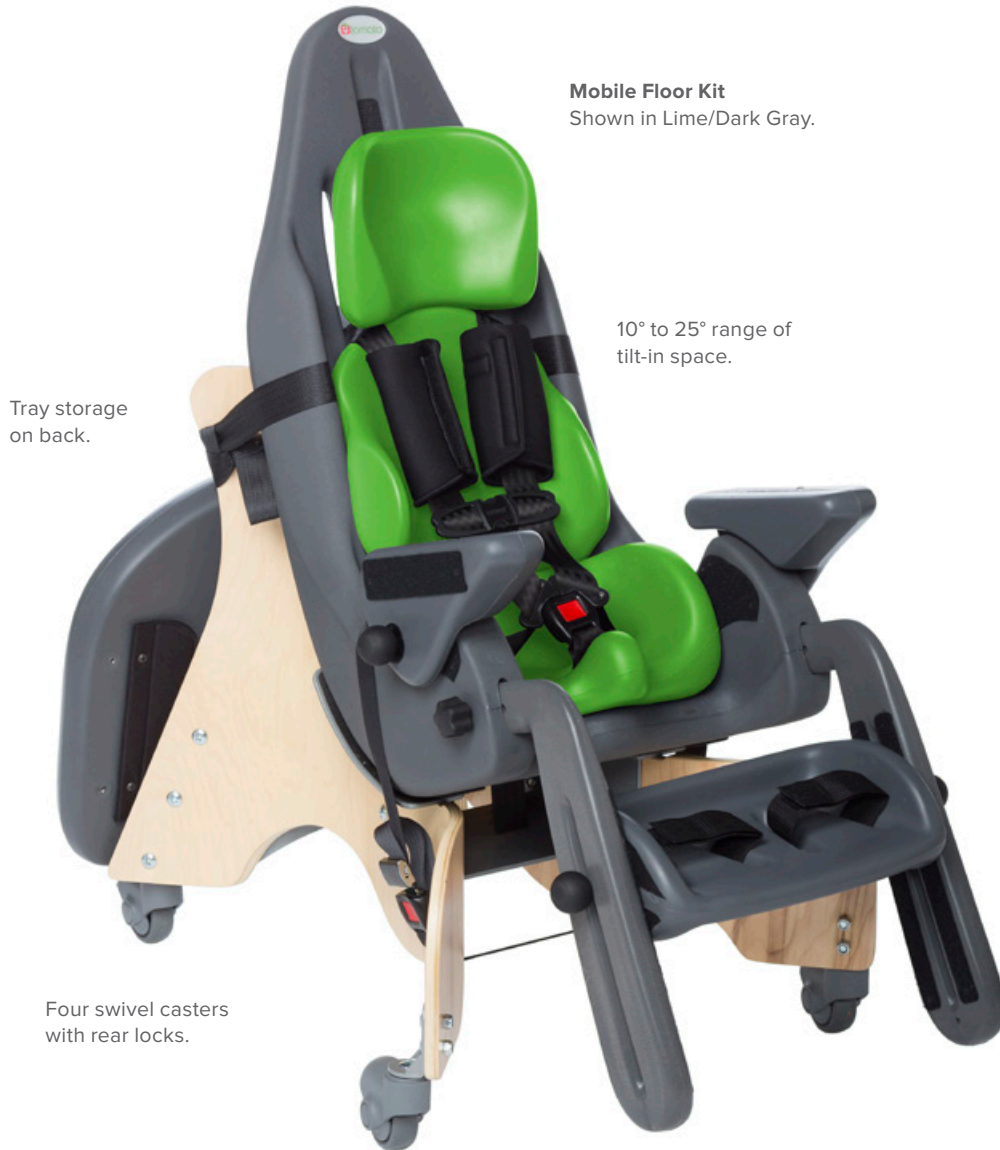

Mobile Floor Kit
Shown in Lime/Dark Gray.

10° to 25° range of tilt-in space.

Tray storage on back.

Four swivel casters with rear locks.



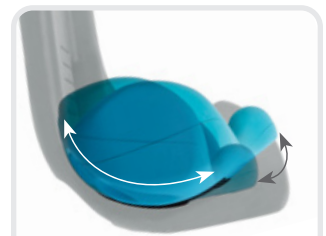

Adjustable Tray
Depth adjustable. 60° tilt adjustment. Tray easily attaches to back of Mobile Floor Base for storage.





Hip-Flex® adjustment provides a range of positions between 15° of hip flexion and 15° of hip extension.

Use the Special Tomato® MPS system everywhere!

 At home, secures to most chairs by using attachment straps

 At school, secure the Special Tomato® in a classroom chair, or use it with the Mobile Base as your all-in-one classroom chair

 In cars, use the crash-tested seat with LATCH and Tether system

 On the school bus, transport the Special Tomato® in Push Chair (79200000, see next page)

 In an airplane, both sizes approved by FAA for air travel for seats purchased after April 1, 2006



Features & Accessories



1 Mobile Floor Base
79070100 Small
79070300 Large

2 Headrest with Laterals
MHL shown in Lilac.
See page 7.

3 Standard Headrest
MHS shown in Cherry.
See page 7.

4 Optional Cushions
MS5 shown in Aqua.
Four sizes of Seat Cushions
and two Back Cushions for
even more growth!

5 MPS Tray
79060159 Dark Gray, Small
79060359 Dark Gray, Large
Depth adjustable. 60° tilt adjustment.
Tray easily attaches to back of Mobile
Floor Base for storage.

6 Push Chair Sun Shade
79210000
Provides protection from the sun and
a convenient window for monitoring.

7 MPS Push Chair Base
79200000 Umbrella style folding
stroller for easy transport. Folds
down to 15"W × 11"H × 48"L. Supports
150 lbs. and weighs only 20 lbs. 30°
fixed seat tilt. Designed for use with
standard tie-down systems for bus or
van transport and meets ANSI/
RESNA WC19 regulations.

8 Push Chair Travel Bag Accessory
79220000

Customize Your Size



Small Shell (MS)



Large Shell (ML)

Shells

Choose a Shell size to determine your options

Options for (MS) Shell

Headrests

MHS (Standard)



7.5"W x 6.5"H

MHL (w/ Laterals)



7"W x 6"H

Back Cushions

MS2



8"W x 8.5"H

MS4



9"W x 11"H

ML2



10"W x 11"H

Seat Cushions

MS1



7"W x 6"D

MS3



9"W x 8"D

MS5



10"W x 10"D

MS7



10"W x 12"D

Options for (ML) Shell

Headrests

MHS (Standard)



7.5"W x 6.5"H

MHL (w/ Laterals)



7"W x 6"H

Back Cushions

ML2



10"W x 11"H

ML4

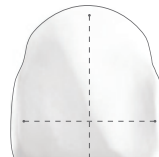

11"W x 13"H

Seat Cushions

ML1

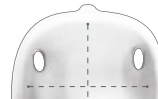

11"W x 11"D

ML3



12"W x 13"D

ML5



13"W x 15"D

ML7



13"W x 17"D

Customize Your Size

Fill in your custom sizes here for ease when ordering

MS

Example

MS

Shell

MHS

Head

MS2

Back

MS1

Seat

	Small MPS Seat Cushions				Large MPS Seat Cushions			
MPS Seat Specifications	MS1	MS3	MS5	MS7	ML1	ML3	ML5	ML7
Target User Age	9 mos - 3 yrs	2 - 5 yrs	4 - 8 yrs	5 - 9 yrs	6 - 9 yrs	8 - 11 yrs	10 - 14 yrs	12 yrs - Adult
Target User Height	28" - 37"	32" - 43"	40" - 50"	43" - 52"	45" - 58"	48" - 60"	48" - 62"	58" - Adult
Maximum User Wt.	80 lbs.				130 lbs.			
Seat Width	7"	9"	10"	10"	11"	12"	13"	13"
Seat Depth	6"	8"	10"	12"	11"	13"	15"	17"
Seat to Footrest	6" - 16"				8" - 18"			
Hip Flex Angle	-15° to +15°				-15° to +15°			
Seat Tilt Angle Forward	5°				5°			
Seat Tilt Angle Back	-30°				-30°			
Floor to Seat Ht.	14" - 28.5"				17" - 28.5"			

	Small MPS Back Cushions		Large MPS Back Cushions	
MPS Back Specifications	MS2	MS4	ML2	ML4
Target User Age	9 mos - 3 yrs	2 - 9 yrs	6 - 9 yrs	8 yrs - Adult
Target User Height	28" - 37"	32" - 52"	45" - 58"	48" - Adult
Maximum User Wt.	80 lbs.		130 lbs.	
Back Width	8"	9"	10"	11"
Back Height	8.5"	11"	11"	13"
Top of Back Cushion	11" - 16"	15" - 20"	15" - 20"	19" - 22"
Top of Head Cushion	18" - 23"	21" - 26"	24" - 28"	26" - 30"

MPS Hi-Low Seating System

79300109 Dark Gray, Small
79300309 Dark Gray, Large
Includes Seat Shell with Footrest,
8-point Harness, Hi-Low Base with
Casters (Must Choose Custom
Seating Cushions Separately)



MPS Tray	Small (79060155)	Large (79060355)
Dimensions	24"W x 17"D x 2"H	
Weight	8 lbs.	



Seat Cushions	Cherry	Lilac	Lime	Aqua	Dark Gray	Light Gray
MS1	79050551	79050552	79050553	79050554	79050559	79050560
MS3	79050151	79050152	79050153	79050154	79050159	79050160
MS5	79050251	79050252	79050253	79050254	79050259	79050260
MS7	79050651	79050652	79050653	79050654	79050659	79050660
ML1	79050751	79050752	79050753	79050754	79050759	79050760
ML3	79050351	79050352	79050353	79050354	79050359	79050360
ML5	79050451	79050452	79050453	79050454	79050459	79050460
ML7	79050851	79050852	79050853	79050854	79050859	79050860

Back Cushions	Cherry	Lilac	Lime	Aqua	Dark Gray	Light Gray
MS2	79120551	79120552	79120553	79120554	79120559	79120560
MS4	79120151	79120152	79120153	79120154	79120159	79120160
ML2*	79120751	79120752	79120753	79120754	79120759	79120760
ML4	79120351	79120352	79120353	79120354	79120359	79120360

Headrests	Cherry	Lilac	Lime	Aqua	Dark Gray	Light Gray
MHS (Standard)	79100051	79100052	79100053	79100054	79100059	79100060
MHL (w/Laterals)	79110051	79110052	79110053	79110054	79110059	79110060

*ML2 designed to fit both the Small and Large system, providing a wider Back Cushion option for Small size systems.
Warranty: 5-Year Manufacturer's Warranty on cushions, and seat shell; 2-Year Manufacturer's Warranty on Hi-Low base, and strapping.

Soft-Touch[®] Sitters 5 year warranty

Supportive, Stylish Seating

Base Styles

Three styles to fit your needs



Sitter with Stationary Base



Sitter with Mobile Base



Floor Sitter Kit for Sizes 1,2,3

Applications

Sitters can be used in a variety of ways



Attach to a chair



Jogger for Sizes 1,2 (page 22)



EIO Push Chair for Sizes 1,2 (page 20)

Features



Sleek modern design provides up to 25° of tilt



Attachment straps for securing to a standard chair



Adjustable 8-point harness



Right angle front brackets help protect feet from caster rollover.



Built-in abductor



Optional Headrest



Soft-Touch[®] Sitters

5 year warranty

Sitter Only

5 sizes available for that "custom" fit



Size 1

Size 2

Size 3

Size 4

Size 5

Customize Your Cushion Color

Three color options available



Lilac



Aqua



Dark Gray

Sitter Specifications	Size 1	Size 2	Size 3	Size 4	Size 5
Target Weight	20 - 30 lbs.	30 - 60 lbs.	40 - 80 lbs.	50 - 110 lbs.	90 - 200 lbs.
Target Height	30" - 35"	35" - 48"	40" - 56"	50" - 65"	54" - 74"
Target Age	1 - 2 years	2 - 6 years	6 - 9 years	9 - 14 years	13 years - Adult
Inside Seat Depth	7"	9.5"	11.5"	13.5"	16"
Inside Seat Width	8"	10"	12"	14"	16"
Seat Back Height	21"	26"	29"	35"	39"
Floor to Seat Ht. UPRIGHT on Stationary Base	10"	10"	9.75"	11.5"	12.5"
Floor to Seat Ht. TILTED on Stationary Base	10.5"	10.5"	10.5"	13"	14.25"
Floor to Seat Ht. UPRIGHT on Mobile Base	12.5"	13.25"	13"	14.75"	16"
Floor to Seat Ht. TILTED on Mobile Base	12.75"	13.75"	13.75"	16"	17.75"
Floor to Seat Ht. UPRIGHT on Floor Base	5"	5.5"	5.5"	N/A	N/A
Floor to Seat Ht. TILTED on Floor Base	4.5"	4.5"	5"	N/A	N/A
Overall Seat Depth	12"	14"	16"	19"	21"
Overall Seat Width	12"	14"	16"	18"	20"
Overall Seat Height	25"	29"	34"	40"	44"
Weight of Seat	6 lbs.	10 lbs.	13 lbs.	15 lbs.	19 lbs.

Base Specifications	Floor Base	Stationary (Small)	Stationary (Large)	Mobile Base (Small)	Mobile Base (Large)
Use with Sitter Sizes	1, 2, 3	1, 2, 3	4, 5	1, 2, 3	4, 5
Overall Width	19"	17.5"	19.25"	17.5"	19.25"
Overall Depth	22.5"	30"	35"	30"	35"
Overall Height	12.5"	16"	23"	19.5"	26.5"
Weight of Base	14 lbs.	12 lbs.	15 lbs.	14 lbs.	17 lbs.
Degree of Tilt	25°	25°	25°	25°	25°

Soft-Touch® Sitters (w/ Gray Harness)	Lilac	Aqua	Dark Gray
Size 1 Sitter Only	77010102	77010104	77010109
Size 2 Sitter Only	77010202	77010204	77010209
Size 3 Sitter Only	77010302	77010304	77010309
Size 4 Sitter Only	77010402	77010404	77010409
Size 5 Sitter Only	77010502	77010504	77010509
Size 1 Sitter on Stationary Base	77110102	77110104	77110109
Size 2 Sitter on Stationary Base	77110202	77110204	77110209
Size 3 Sitter on Stationary Base	77110302	77110304	77110309
Size 4 Sitter on Stationary Base	77110402	77110404	77110409
Size 5 Sitter on Stationary Base	77110502	77110504	77110509
Size 1 Sitter on Mobile Base	77210102	77210104	77210109
Size 2 Sitter on Mobile Base	77210202	77210204	77210209
Size 3 Sitter on Mobile Base	77210302	77210304	77210309
Size 4 Sitter on Mobile Base	77210402	77210404	77210409
Size 5 Sitter on Mobile Base	77210502	77210504	77210509
Size 1 Floor Sitter	78010102	78010104	78010105
Size 2 Floor Sitter	78010202	78010204	78010209
Size 3 Floor Sitter	78010302	78010304	78010309

Optional Items	Part No.
Optional Floor Sitter Wedge (fits sizes 1-3 sitter)	78000009
Optional Small Stationary Base (fits sizes 1-3 sitter)	77100100
Optional Small Mobile Base (fits sizes 1-3 sitter)	77200100
Optional Headrest	77020000
Optional Large Stationary Base (fits sizes 4-5 sitter)	77100200
Optional Large Mobile Base (fits sizes 4-5 sitter)	77200200

Mobile Activity Tray

2 year warranty



Portable and Versatile Tray for Everyday Use

- Two sizes: Short and Tall
- Height adjustable tray surface
- Angle adjustable tray surface
- Easy to move around a room
- Four tray surface color options



3" (10cm) front swivel casters lock



4" (7.6cm) fixed rear casters allow for easy access and keep the tray secure



Mobile Activity Tray			
Mobile Activity Tray Short - Lilac	65000102	Mobile Activity Tray Tall - Lilac	65000302
Mobile Activity Tray Short - Aqua	65000104	Mobile Activity Tray Tall - Aqua	65000304
Mobile Activity Tray Short - Chocolate	65000105	Mobile Activity Tray Tall - Chocolate	65000305
Mobile Activity Tray Short - Dark Gray	65000109	Mobile Activity Tray Tall - Dark Gray	65000309

Mobile Activity Tray - Short Specifications	
Lowest Floor-to-tray surface	16" H
Highest Floor-to-tray surface	21" H
Weight	24lbs.
Tray Dimensions	28" W x 20" D

Mobile Activity Tray - Tall Specifications	
Lowest Floor-to-tray surface	20" H
Highest Floor-to-tray surface	28" H
Weight	29lbs.
Tray Dimensions	28" W x 20" D

Features

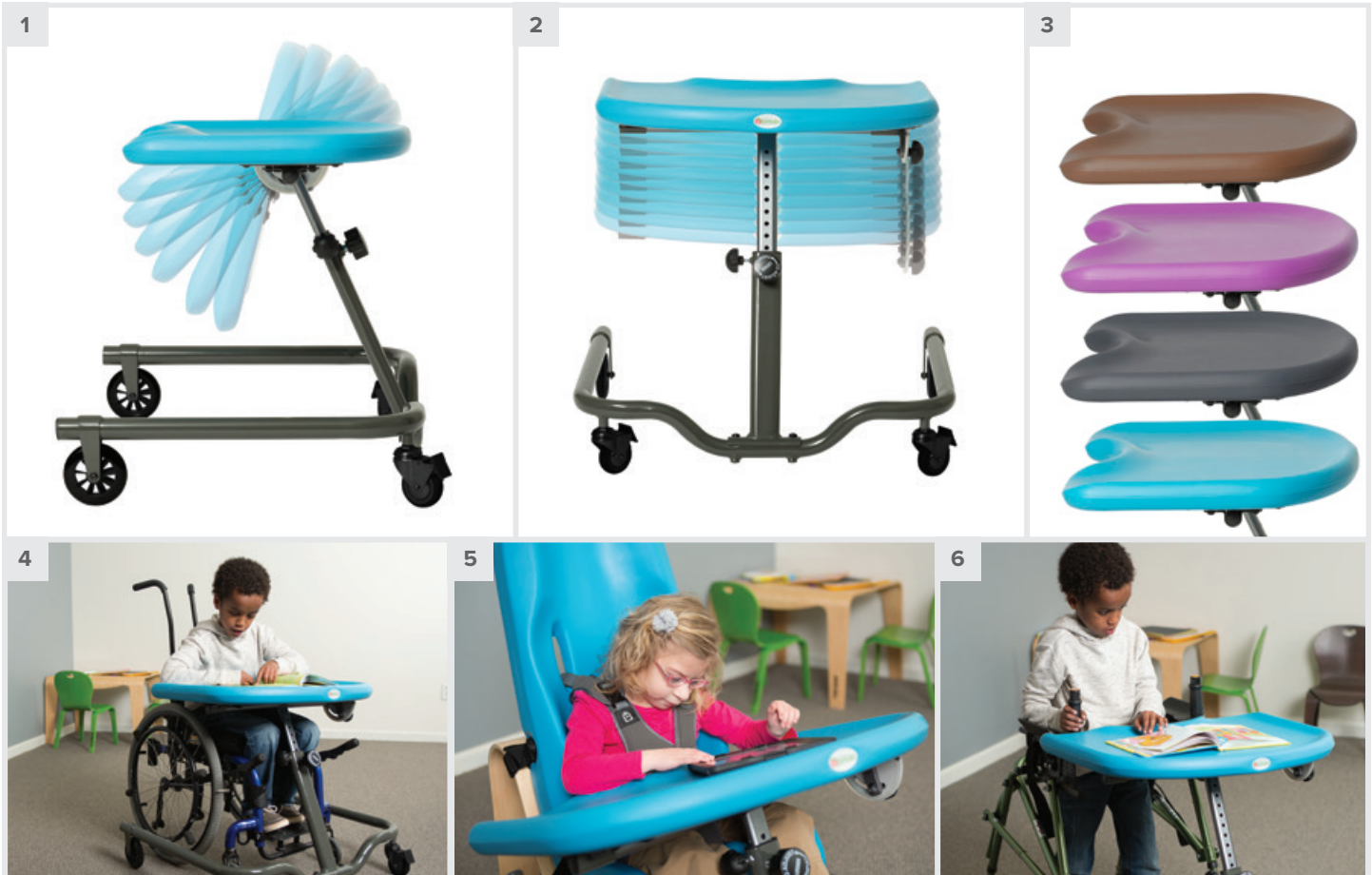

1 Tray Tilt Angle
0 - 80 degrees.

2 Tray Height Adjustment
Short: 16-21".
Tall: 20-28".

3 Colorful Options
Vibrant color choices.

4 Use with Wheelchair
28" wide base opening gives many wheelchair users access to the Mobile Activity Table.

5 Use with Soft-Touch® Sitters
Designed to integrate with the Soft-Touch® Sitters for a variety of activities.

6 Use with Walker
28" wide base allows children with walkers access to the Mobile Activity Table from a standing position.

Soft-Touch[®] Liners 5 year warranty

Upgrade Your Strollers and Chairs with Portable Positioning

- Portable, lightweight and durable
- Versatile for use in strollers, chairs or wheelchairs
- Easy to clean
- Expands seating options
- Great for school and home use
- Affordable: fits easily into most budgets



Size 1 shown in Dark Gray



Size 2 shown in Cherry



Item	Cherry	Lilac	Aqua	Dark Gray	Inner Dimensions	Overall Dimensions
Size 1 Seat Cushion	72040101	72040102	72040104	72040109	8"W × 8"D × 3.5"H	10.5"D × 11"W
Size 2 Seat Cushion	72040201	72040202	72040204	72040209	10"W × 10"D × 4"H	13"D × 12"W
Size 3 Seat Cushion	72040301	72040302	72040304	72040309	12"W × 12"D × 4.5"H	15"D × 14"W
Size 1 Back Cushion*	72050101	72050102	72050104	72050109	7.5"W × 10"H	10"H × 10.5"W
Size 2 Back Cushion*	72050201	72050202	72050204	72050209	8.5"W × 13.5"H	13.5"H × 12.25"W
Size 3 Back Cushion*	72050301	72050302	72050304	72050309	10"W × 14.5"H	14.5"H × 13.25"W

*Depth of Back Cushions are 1" at the narrowest point and 4" at the widest point

Please Note: Only Liner Sizes 1 and 2 can be inserted into the EIO Push Chair and Tomato Jogger.

Features



Fits many chair options in classroom and home
Size 3 shown in Cherry



Use size 1 and 2 Liners with Jogger (Sold Separately)



Use size 1 and 2 Liners with EIO Push Chair (Sold Separately)



Straps together for easy carrying and storage



3-point pelvic harness helps to safely secure the hips

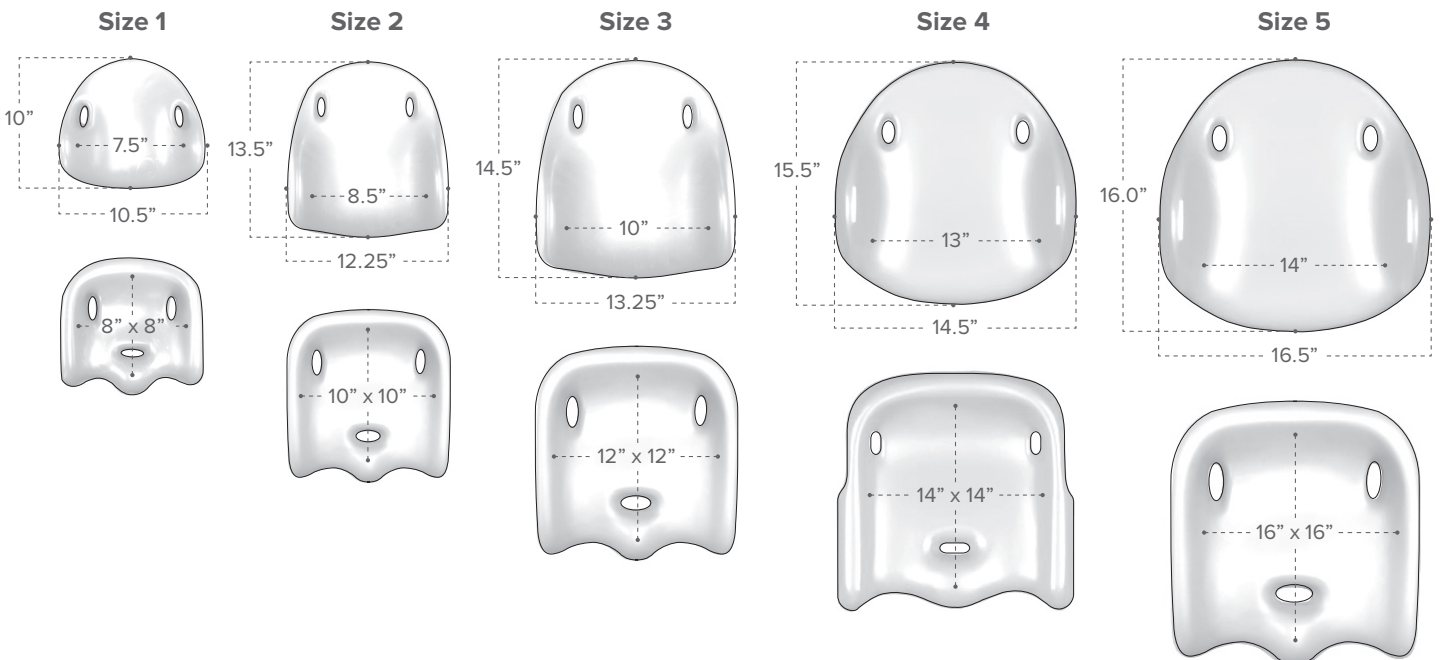

Portable Potty Seat 5 year warranty

Convenient Comfort

Elongated Potty Seat

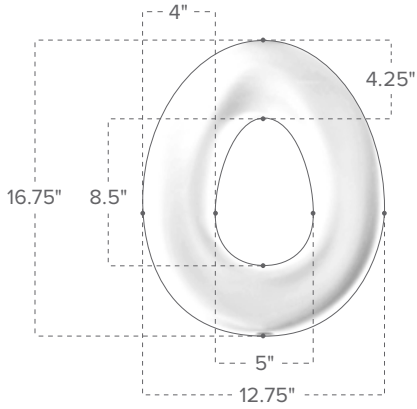

Round Potty Seat

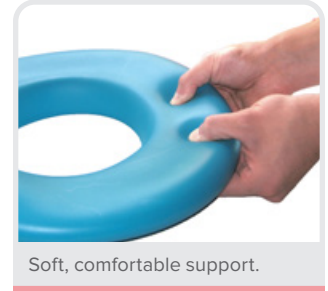
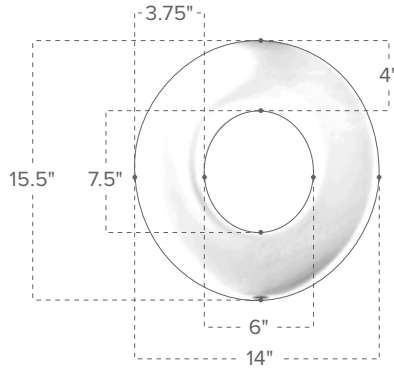

Item	Cherry	Lilac	Lime	Aqua	Dark Gray	Light Gray
Round Seat Cushion	74010001	74010002	74010003	74010004	74010009	74010010
Elongated Seat Cushion	74020001	74020002	74020003	74020004	74020009	74020010





Soft-Touch® Therapy Rolls & Wedges

Comfortable Therapeutic Support



Soft-Touch Rolls		
Diameter/ Length	Aqua	Dark Gray
3" x 8"	75000104	75000109
4" x 24"	75000204	75000209
6" x 24"	75000304	75000309
8" x 24"	75000404	75000409
8" x 36"	75000504	75000509
10" x 36"	75000604	75000609
12" x 36"	75000704	75000709

Soft-Touch Wedges			
Elevation/ Width/Length	Incline	Aqua	Dark Gray
4" x 20" x 22"	10°	76000104	76000109
6" x 20" x 22"	16°	76000204	76000209
8" x 20" x 22"	20°	76000304	76000309
6" x 24" x 28"	12°	76000404	76000409
8" x 24" x 28"	16°	76000504	76000509

Rolls

- Great for postural therapy, balance, flexion and extension and neurodevelopment
- Solid Core provides firm platform (except 75000104, 75000205, 75000204 and 75000205)
- Stand-On-End™ Design for security and stability when not in use

Wedges

- Ideal for adaptive positioning, balance, and muscle tone control
- Also recommended for dynamic movement patterns and fine and gross motor activities
- Stand-On-End™ Design for security and stability when not in use
- Integrated Soft-Touch® handle for easy carrying

EIO Push Chair

2 year warranty

Affordable Chair and Positioning

- Designed for children from early intervention to pre-adolescent ages
- Easy to fold and transport
- Lightweight aluminum frame
- Calf panel and seat back lay your child flat
- Standard features: see next page

Special Tomato® EIO Push Chair - 63000000	
Stroller Only Seat to Foot Well	13"
Liners Size 1 and 2 Seat to Foot Well	15"
Sitter Size 1 Seat to Foot Well	16"
Sitter Size 2 Seat to Foot Well	17"
Open Chair Dimensions	45"H × 24"W × 46"D
Folded Chair Dimensions	16"H × 18"W × 32"D
Handle Height to Floor	30" - 43"
Seat	14"W × 12"D
Back Height	24"
Max. User Weight	90 lbs.
Stroller Weight	22 lbs.

Includes 2-position foot-block.



Features & Accessories



1 Size 1 and 2 Soft-Touch® Liners

Attach to the stroller, with color choice of Cherry, Lilac, Aqua or Dark Gray. Sold separately, see page 16.

2 Size 1 and 2 Soft-Touch® Sitters

Attach to the stroller, with color choice of Lilac, Aqua or Dark Gray. Sold separately, see page 9.

3 Adjustable 8-point Harness

5-Point comfort trunk harness with padded shoulders and chest strap. Also includes a padded 3-point pelvic harness for hip and lateral support.

4 Shopping Basket

10 lb. weight capacity.

5 Angle Adjustable Seat Back

(25° to 75°) and foot well (+15° to -55°).

6 Solid Filled Wheels

Solid filled 9" front and 11" rear wheels require no air. Swivel front wheels with lock-out feature add security on rough terrain. Includes one-touch parking brake.

7 Sun Shade

Adjustable push handle, padded headrest and removable sun canopy with window, which includes a large pocket.

8 Rain Cover

63030000
Sold separately.

Jogger

2 year warranty

Supportive Style On-the-Go

- Designed for parents and families who want to take long strolls through the city or through rough trails
- Easy to fold and transport
- Lightweight aluminum frame
- Includes 8-point trunk / pelvic harness system

Special Tomato® Jogger - 62000000	
Stroller Only Seat to Foot Well	14"
Liners Size 1 and 2 Seat to Foot Well	16"
Sitter Size 1 Seat to Foot Well	17"
Sitter Size 2 Seat to Foot Well	18"
Open Chair Dimensions	43"H × 26"W × 42"D
Folded Chair Dimensions	16"H × 33"W × 21"D
Handle Height to Floor	35" - 43"
Seat	14"W × 12"D
Back Height	25"
Recline Range	100° - 140°
Max. User Weight	110 lbs.
Stroller Weight	27 lbs.



Features & Accessories



- 1 Size 1 and 2 Soft-Touch® Liners**
 Attach to the stroller, with color choice of Cherry, Lilac, Aqua or Dark Gray. Sold separately, see page 16.
- 2 Size 1 and 2 Soft-Touch® Sitters**
 Attach to the stroller, with color choice of Lilac, Aqua or Dark Gray. Sold separately, see page 9.
- 3 Added Comfort**
 Padded upholstery with reclining back support, functional rear suspension and foot well with side guard.
- 4 Pneumatic Wheels**
 Front 12" pneumatic swivel wheel with lock-out and quick-release 12" rear pneumatic wheels.
- 5 One-step, compact folding design**
 Canopy folds with Jogger.
- 6 Sun Shade**
 Removable canopy with window and height adjustable handle.
- 7 Medical Necessities Bag**
 62010000
 Sold separately.
- 8 Head Support**
 62020000
 Sold separately.
- 9 Rain Cover**
 62030000
 Sold separately.

Size Help

Good Fit Sizing Service™ is free!

Available at www.specialtomato.com/sizehelp.html

- Provide measurements and the product(s) you are interested in and we'll let you know if it will work!



Children's Measurements

- 1 Shoulder Width
- 2 Trunk Width
- 3 Hip Width
- 4 Thigh Depth
- 5 Foot to Knee
- 6 Buttocks to Shoulder
- 7 Buttocks to Head

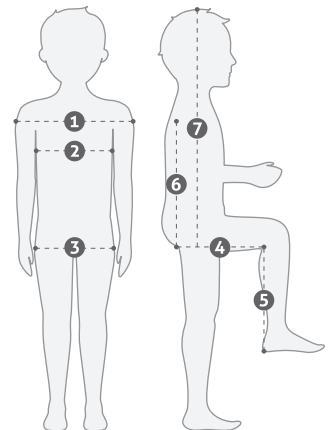

The Special Tomato Story



My dad and mom had four children. The first three were healthy and regular people. Then I came along; a baby with a difference—Down syndrome.

One day it was bothering me that I was having a hard time doing my school work. My dad shared a story about his tomato garden. Once, at harvest time, a differently shaped tomato got his attention. It had a large, bright red bump that made my dad want to pick it up and study it because it was so unique and looked appetizing. At dinner, that tomato was just as juicy as the others.

Even though I'm different—like the tomato—as a person with Down syndrome, my lovable and outgoing personality and strong character make me just as special as everyone else. I guess I am the special "tomato" in our family's garden!

Carrie Bergeron



Peggy, Tim and
Carrie Bergeron
(from left to right)



CONTACT INFO

