

SOMA

Manual Wheelchair Owner's Manual

Econ 800 Series

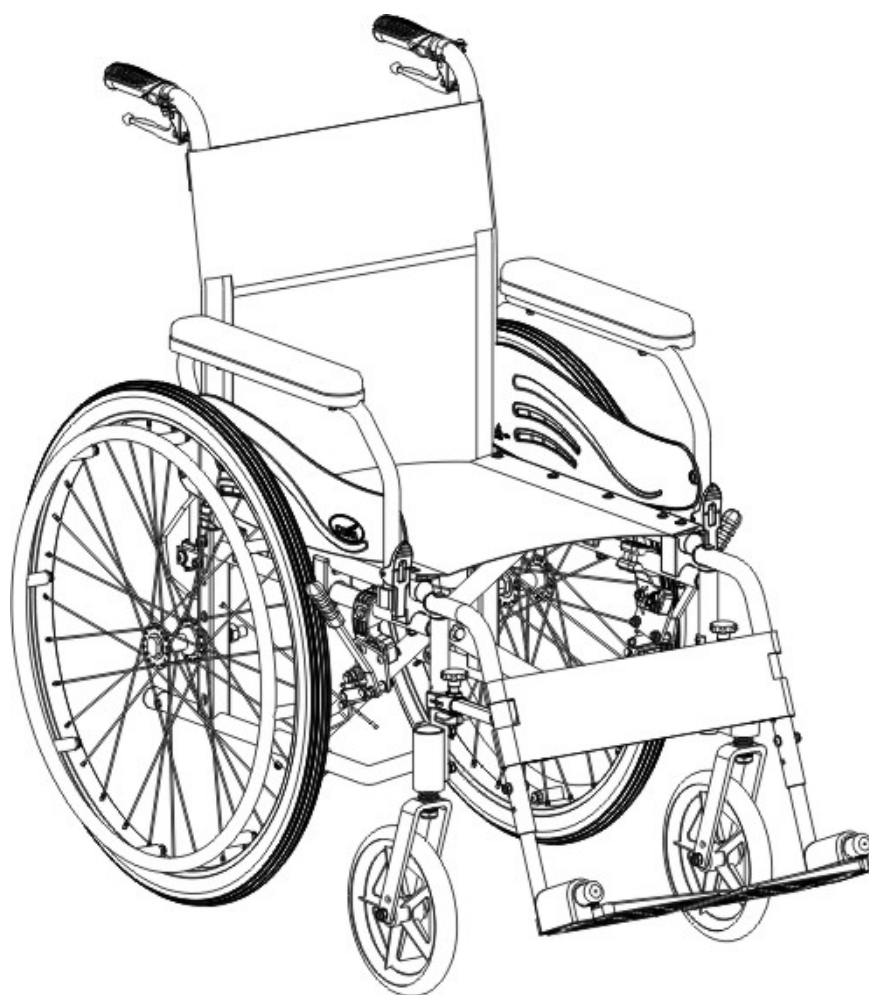

ISO 9001

GENERAL WARNING

- DO maintain your chair well, in particular check the tire pressure since this affects the efficiency of the brakes.
- DO make sure both brakes are applied before getting in or out of the chair.
- DO make sure both brakes are applied when the chair is not being pushed or used.
- DO take care when climbing curbs or turning on slopes.
- DO avoid steep or uneven surfaces that may cause the chair to tip over.
- DO avoid soft surfaces because the casters may become bogged down.
- DO travel smoothly in all conditions.
- DO look well ahead to anticipate hazards such as furniture, doors, potholes, etc.
- DO make sure that both feet are safely on the footrests and that clothing is safely tucked out of the way so that it cannot get caught in the wheels.
- DO take care when traveling up or down or across inclines.
- DO keep both hands on the push handles to control the chair, if you are the attendant.
- DO pay attention to keep the chair balanced.
- DO check the frame and components regularly and refer to this user guide during and after the warranty period.
- DO tie-up the upholstery or replace which with a new one when it becomes loose.
- DO lubricate the bearings regularly.
- DO equip with anti-tippers to avoid falling backwards.
- DO equip with a seat belt designed for disabled people.
- DO equip with "heel loops" for disabled people.
- DO be far away of flame, it might injury user and damage the chair.
- DO clean both hands after oiling the wheelchair.
- DO Not overload the chair in any circumstance.
- DO Not hang anything heavy on the back of the chair that could cause the chair to become unstable, particularly when negotiating inclines.
- DO Not allow more than one user at a time.
- DO Not use with an unconscious patient.
- DO Not use other transport to pull the wheelchair.
- DO Not do "wheelies", since you may fall or tip over backwards and suffer a severe injury.
- DO Not sit in the wheelchair within a moving vehicle.
- DO Not go too fast or turn too quickly.
- DO Not stand on the footplates when getting in or out of the chair.
- DO Not go down steps forward, whether solo or with an attendant.
- DO Not attempt to lift the wheelchair by any removable (detachable) parts. Lifting by means of any removable (detachable) parts of the wheelchair may result in injury to the user and/or assistant or damage to the wheelchair.

- DO NOT use the wheelchair when the back is folded. This alters the centre of gravity and may cause the wheelchair to tip backwards. The back should only be folded for storage or transport of the wheelchair.
- DO Not hang anything on the back joint that could cause the backrest to fold suddenly and may cause injury.

YOU AND YOUR KARMA SERVICE PROVIDER

- No tools are required for assembly. Your wheelchair should be assembled by your authorized Karma dealer. Your authorized Karma dealer is also your service provider. Unauthorized repairs, upgrades and add-ons will negate your warranty. Anything wheelchair related that requires tools should be done by your authorized Karma service provider. Your Karma service provider has the necessary service/maintenance manual for your wheelchair.
- If you have any defective parts or lose any parts, please contact your dealer for repair and/or replacement. Please only use parts authorized by Karma. Use of parts that are not authorized by Karma will negate your warranty.
- Part numbers are listed on our bill of materials (explosion drawings), which we give to our authorized dealers and service providers. Customers should order parts through their dealer as well as all repairs and scheduled maintenance.
- Customers should go to their dealership for all service needs to guarantee their warranty is not nullified. Always go to an authorized service provider. Unauthorized repairs will nullify your warranty. Procedures other than those described in this manual must be performed by a qualified technician. They also have the service manual with a complete list of maintenance required to keep your Karma wheelchair in top performance. Check the warranty section of this manual to find out what Karma guarantees and what maintenance service and parts that are not covered by the warranty.
- Karma does not have an official list of service providers at this time. Please contact your dealer for service. If you cannot contact your dealer, please contact another authorized Karma dealer for service. If all else fails, contact Karma directly via our website or give us a call and we can refer you to your new service provider.

CE MARKING

This wheelchair complies with the requirements of the Medical Devices Directive 93/42/EEC.



CAUTION:

- When prescribing wheelchairs for use by full or partial amputees (above or below knee, single or double) or other conditions that affects the user's natural center of gravity and might cause the wheelchair to tip or the person on the wheelchair to fall off, we suggest contacting your therapist or dealer as well as attaching anti-tippers, pelvic belt, or other additional safety accessories.
- When using the wheelchair, ALWAYS follow the Highway Code or your local traffic regulations when outdoors and the guidelines written in this manual.



TABLE OF CONTENTS

TABLE OF CONTENTS	1
1. PREFACE	1
2. SAFETY	2
3. INTENDED USE & PARTS	5
4. OPERATION	8
5. INSPECTION AND MAINTENANCE.....	19
6. OPTIONS AND ACCESSORIES.....	23
7. TROUBLESHOOTING	24
8. SPECIFICATIONS	25
9. CLEANING & RECYCLING	26
10. WARRANTY	27

1. PREFACE

Please carefully read this owner's manual before using the wheelchair. Improper use of the wheelchair could result in harm or injury. Therefore, for safe and enjoyable use of the wheelchair, please read this owner's manual.

- This owner's manual includes operation instructions for the aspects of the wheelchair, unfolding/folding instructions and instructions on how to deal with possible accidents.
- This owner's manual is written for Karma wheelchair: Econ 800 (SM-802.2).
- The symbols used in this manual are explained below. Pay special attention to the parts marked with these symbols.

	WARNING:	Improper use could lead to serious injury or death.
	CAUTION:	Improper use could lead to serious injury and/or damage to your wheelchair.
	SUGGESTION:	Follow these instructions to keep the wheelchair in good condition.

- This manual includes the repair and maintenance chart as well as the warranty.
- If someone else uses the wheelchair, make sure that you give him or her this owner's manual for his or her reference.
- As designs change, some illustrations and pictures in this manual may not correspond to the wheelchair that you purchased. We reserve the right to make design modifications without further notice.

2. SAFETY

2.1 Doorways

The safest way to operate the chair is on level floors that are free of obstacles. Whenever possible use a ramp to enter or exit a facility. Keeping your hands on the push rims will allow you to maintain maximum balance. Do not try to force yourself over an obstruction by propulsion and never use the sides of a doorway to pull yourself through a passageway.

2.2 Leaning

Do not lean over the side of your wheelchair since such an action may cause you to lose balance and fall. (See Figure 2.1)

2.3 Navigating Inclines

- Never turn on a hill due to the danger of tipping.
- When assisting, go straight up a slope. If user needs to go down midway, walk backwards until user is on level ground. (See Figures 2.2 and 2.3)
- Avoid stopping on an incline; it can potentially cause you to lose control of the chair.
- Do not use the brakes to slow down or stop the wheelchair; this could cause it to seize up, causing you to lose control or fall out of the chair.
- Whenever possible, utilize help from an assistant/attendant while navigating inclines.

2.4 Kerbs

- Whenever possible get help from an assistant/attendant (if you have assistance make sure that your chair is equipped with push handles).
- Avoid hard impacts when descending a kerbs. A hard impact could adversely affect the chair.
- Never try to scale or descend kerbs that exceed a normal height.(30-50mm)
- Always be careful when climbing kerbs and never move up or down a kerbs in reverse without an assistant.

2.5 Stairs

- Always use two or more assistants.
- Never go down steps forwards.
- Never use an escalator for transport, use an elevator.

2.6 Streets

- Always use extreme caution when crossing streets. Reflective tape on the chair and/or your clothing will make you more visible to drivers.
- Avoid potholes and rough terrain that might cause the casters to become stuck. (See Figure 2.4)

2.7 General

- Always make sure BOTH brakes are applied before getting in or out of the chair.
- Never stand on the footplates when getting in or out of the chair.
- Never carry more than one passenger. Karma wheelchairs are limited to one user.
- Use caution to assure your clothing doesn't get tangled with the wheels.

- When the user is operating the wheelchair using the pushrim, please push the wheelchair gently. DO NOT apply a sudden huge force on the pushrim. It could cause the chair to tip over. Please refer to the figure below for the best grip points for using the pushrim.

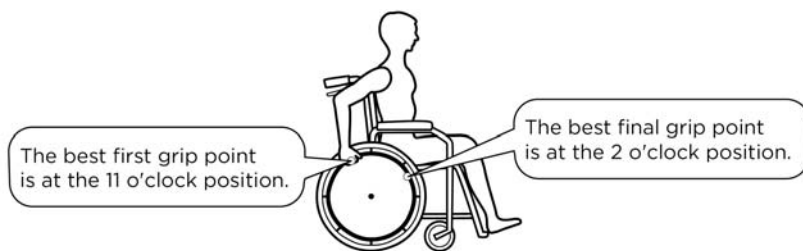

2.8 Transport

- Do not use other transportation to pull the wheelchair.
- Do not get transported on any vehicle while seated in your wheelchair. Karma doesn't approve of any tie-down systems. Please transfer into seating approved by the automotive (or other) industry and wear a safety belt.

2.9 Upholstery

- When cleaning the upholstery, use warm water and a mild soap.
- Upholstery cleaner/foam can also be used, but avoid other cleaning solvents.

2.10 Anti-tippers

Please purchase anti-tippers and always use them to avoid personal injury.

2.11 Maximum User Weight Limit

Refer to "Max. User Weight" in Section 8. SPECIFICATIONS. Loads exceeding maximum capacity can damage your wheelchair and cause malfunctions yielding a safety hazard. The warranty does not cover damage caused by improper operation of the wheelchair.

2.12 Avoid General Misuse

- Please note that our "Owner's Manual" contains a number of cautions -- any vehicle can cause injury if misused -- use within our guidelines and with reasonable care and your safety will be increased. Your wheelchair will give years of safe use if used sensibly and carefully. Be aware that careless use endangers your own safety as well as that of others.
- Do not let children stand or play on the wheelchair. (See Figure 2.5)



Figure 2.1



Figure 2.2



Figure 2.3



Figure 2.4



Figure 2.5

2.13 Labeling

Please carefully read all the labeling on the wheelchair before driving it. Do not remove them. Protect them for future reference.



1



3

Model:	
Order No.:	
Delivery Date:	
Sewing No.: <input type="checkbox"/> 1 <input type="checkbox"/> 2 <input type="checkbox"/> 3 <input type="checkbox"/> 4 <input type="checkbox"/> 5 <input type="checkbox"/> 6	
Seat Width	Seat Depth
<input type="checkbox"/> 13	<input type="checkbox"/> 13
<input type="checkbox"/> 14	<input type="checkbox"/> 14
<input type="checkbox"/> 15	<input type="checkbox"/> 15
<input type="checkbox"/> 16	<input type="checkbox"/> 16
<input type="checkbox"/> 17 <input type="checkbox"/> 0	<input type="checkbox"/> 17 <input type="checkbox"/> 0
<input type="checkbox"/> 18 <input type="checkbox"/> 5	<input type="checkbox"/> 18 <input type="checkbox"/> 5
<input type="checkbox"/> 19	<input type="checkbox"/> 19
<input type="checkbox"/> 20	<input type="checkbox"/> 20
<input type="checkbox"/> 21	<input type="checkbox"/> 21
<input type="checkbox"/> 22	<input type="checkbox"/> _____
<input type="checkbox"/> _____	<input type="checkbox"/> _____
karma	Unit: inch

2



3. INTENDED USE & PARTS

3.1 Intended Use

- The Econ 800 series (SM-802.2) is a self-propelled chair. That is, it can either be pushed by an attendant or by the patients themselves.
- These wheelchairs are suitable for users up to 115 kg in weight. Hand brakes are provided for both rear wheels.
- It has pneumatic tires for traction and comfort. It also has an extremely durable aluminum alloy frame with tough accessories and does not suffer in dramatic extremes of temperature (neither user nor attendant need to touch metal parts in normal use).
- The casters have PU tires for greater durability; pneumatic casters are available on request.
- Rear wheels are 24 inches in diameter and solid PU tires are available on request.

3.2 Econ 800 Parts Description

3.2.1 Econ 805 Parts Description

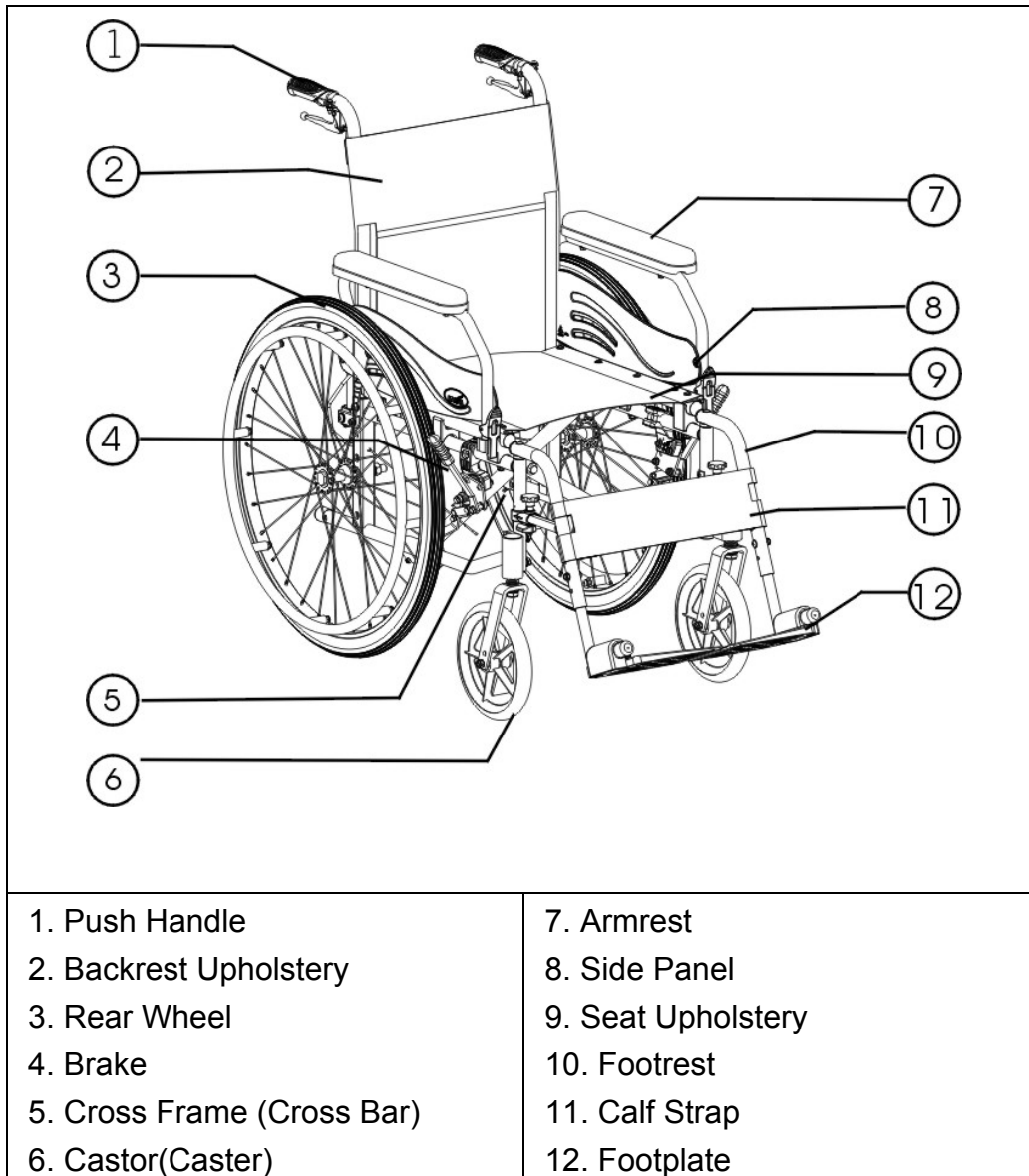

3.2.2 Econ 805 Parts Description

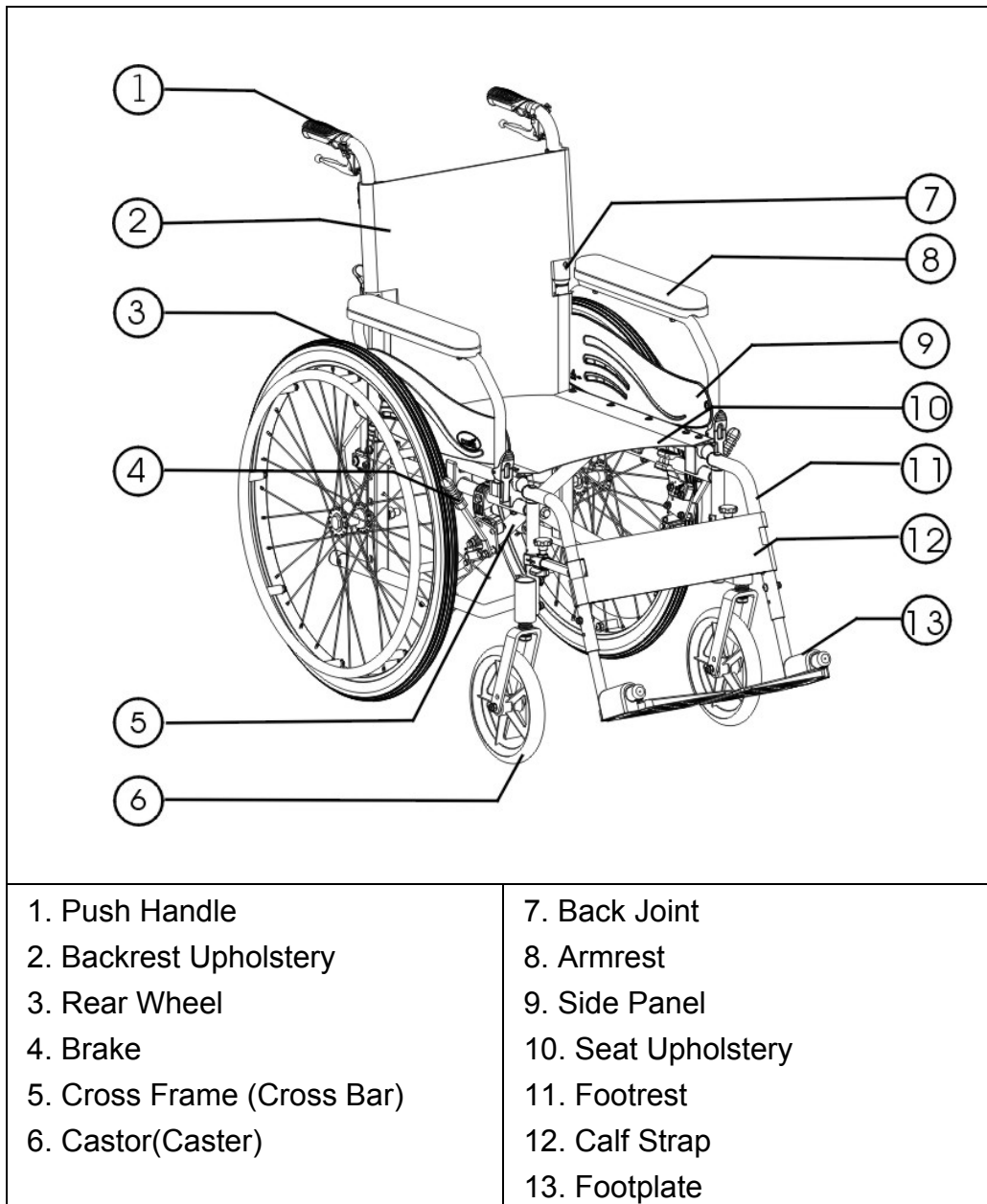

4. OPERATION

4.1 Preparing For Use

4.1.1 Unfolding

- Holding the armrests, pull outwards. (See Figure 4.1)
- Pointing your fingers inward with the palm of your hand on the frame, push down until the seat is fully lowered. Make sure the frame is firmly seated in its holder. (See Figure 4.2)
- Connect the hook and loop fabric on the bottom of the backrest upholstery to the underside of the seat. (See Figure 4.3)
- Place the holes at the top of the footrest arm over the dome studs on the front of the wheelchair. Swing the footrest towards the middle until you hear it click into place. (See Figure 4.4)
- Flip the footplates down. (See Figure 4.5)
- Ready for action! (See Figure 4.6)

Alternatively, you can stand at the side of the chair and complete step 1 by pulling the nearest armrest towards you and pushing the other one away.



Figure 4.1



Figure 4.2



Figure 4.3



Figure 4.4



Figure 4.5



Figure 4.6



CAUTION:

When completing step 2 never put your fingers around the sides or under the chair as they can be trapped between the seat and the frame. (See Figure 4.7)

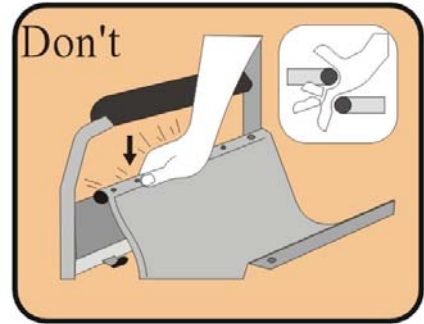

Figure 4.7

4.1.2 Folding

- Flip up the footplates. (See Figure 4.8)
- Pull the swing-away footrest release lever inwards and the footrest will swing-away automatically. Then, lift the footrest arm off of its dome stud mounting posts. (See Figure 4.9)
- Separate the hook and loop fabric of the seat's underside from the backrest upholstery. (See Figure 4.10)
- Pull up on the seat upholstery by holding it in the center of its front and back edge. (See Figure 4.11)
- Press the two release levers on the backrest frame (push handle tubes) to fold the backrest down for compact storage and easy transport. (See Figure 4.12)
- Folding is now completed.



Figure 4.8



Figure 4.9



Figure 4.10



Figure 4.11



Figure 4.12



CAUTION:

Be careful not to get your fingers caught when folding the wheelchair.

4.1.3 Adjustments

4.1.3.1 Armrest

Armrest flips back by pressing the release lever located at the front base of the armrest. After you press the release lever, you can lift and rotate the armrest backwards. (See Figures 4.13 and 4.14)

The height adjustable armrest feature is optional. If your model has it, simply loosen and remove the knob bolt, then adjust the armrest to the desired height and finally reattach the knob bolt.



Figure 4.13



Figure 4.14

4.1.3.2 Rear Wheel

Your wheelchair may be supplied with quick-release wheels. If so, please follow the instructions below.

4.1.3.2.1 Rear Wheel Removal

- Support the weight of the chair with one hand by holding the push handle.
- Depress the hub cover and hold down the quick-release mechanism.
- Remove the wheel. (See Figure 4.15)

4.1.3.2.2 Rear Wheel Attachment

- Pick up the wheel: Hold the center of the rear wheel by grasping two adjacent spokes with four fingers of one hand, use the thumb to depress and keep depressed the quick-release. Take the quick-release axle and depress the button in its center. This retracts the bearings at the opposite end of the axle. This will allow you to push the axle through the center of the hub of the wheel. Your wheels are now ready to be assembled to the frame of your wheelchair.
- First ensure that the brake is in the OFF position. Take up the assembled wheel and axle and depress the button in the center of the axle, as above. This retracts the ball bearings that will allow you to push the axle into the wheel bracket that is located on the lower rear frame of the wheelchair. When you remove your thumb from the button on the axle, the ball bearings should be visible protruding from the axle at the back of the wheel

bracket. This will secure the wheel safely in the frame. (See Figure 4.16)



CAUTION:

- You must make sure that the axle is fully located in the wheelchair bracket and that the ball bearings are fully open and have positively attached the wheel in the frame.
- The rear wheel can be mounted at different positions on the frame to alter the seat height and overall stability of the chair. Changing the wheel position should be carried out by your approved repairer or therapist.

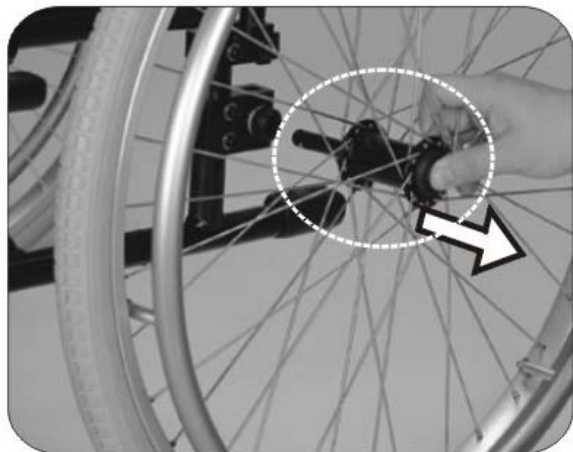

Figure 4.15

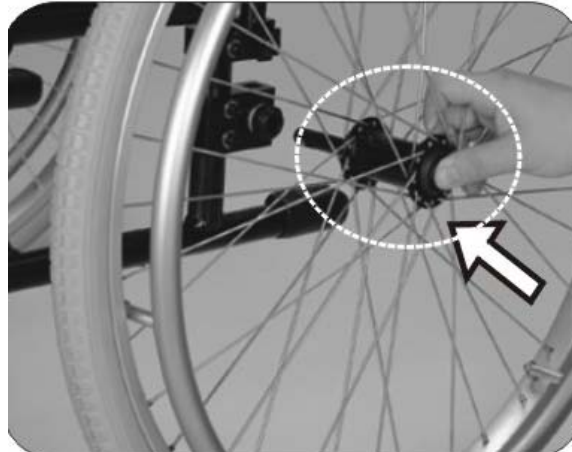

Figure 4.16

4.1.3.2.3 Important DO's and DON'Ts

- Do: Keep axles clean and lubricated with light oil or maintenance spray.
- Do: Maintain correct tire pressure if using pneumatic tires.
- Do not: Try to remove the wheels while the wheelchair is occupied even when using anti-tippers.

4.1.3.3 Footrest

Footrests can rotate out and are detachable, which makes transferring in tight spaces easier and makes it easier to work at a desk. (See Figures 4.17)

4.1.3.4 Footplate Height

- To adjust footplate height use the Karma tool provided to loosen the bolt at the side of the footrest arm.
- Adjust to required height and re-tighten the screw and make sure the footplate is firm. Then tighten the nut as a locknut from outside. (See Figure 4.18)



Figure 4.17



Figure 4.18



Figure 4.19



SUGGESTION:

- Make sure that the footplate height is adjusted properly according to the user's calf length to reduce pressure on the body.
- The footrest height must be more than 5 cm. (See Figure 4.19)

4.1.3.5 Seat Height

- The following information is for your reference only. It will be utilized by your authorized service agent and your therapist to customize the wheelchair to your specific body dimensions.

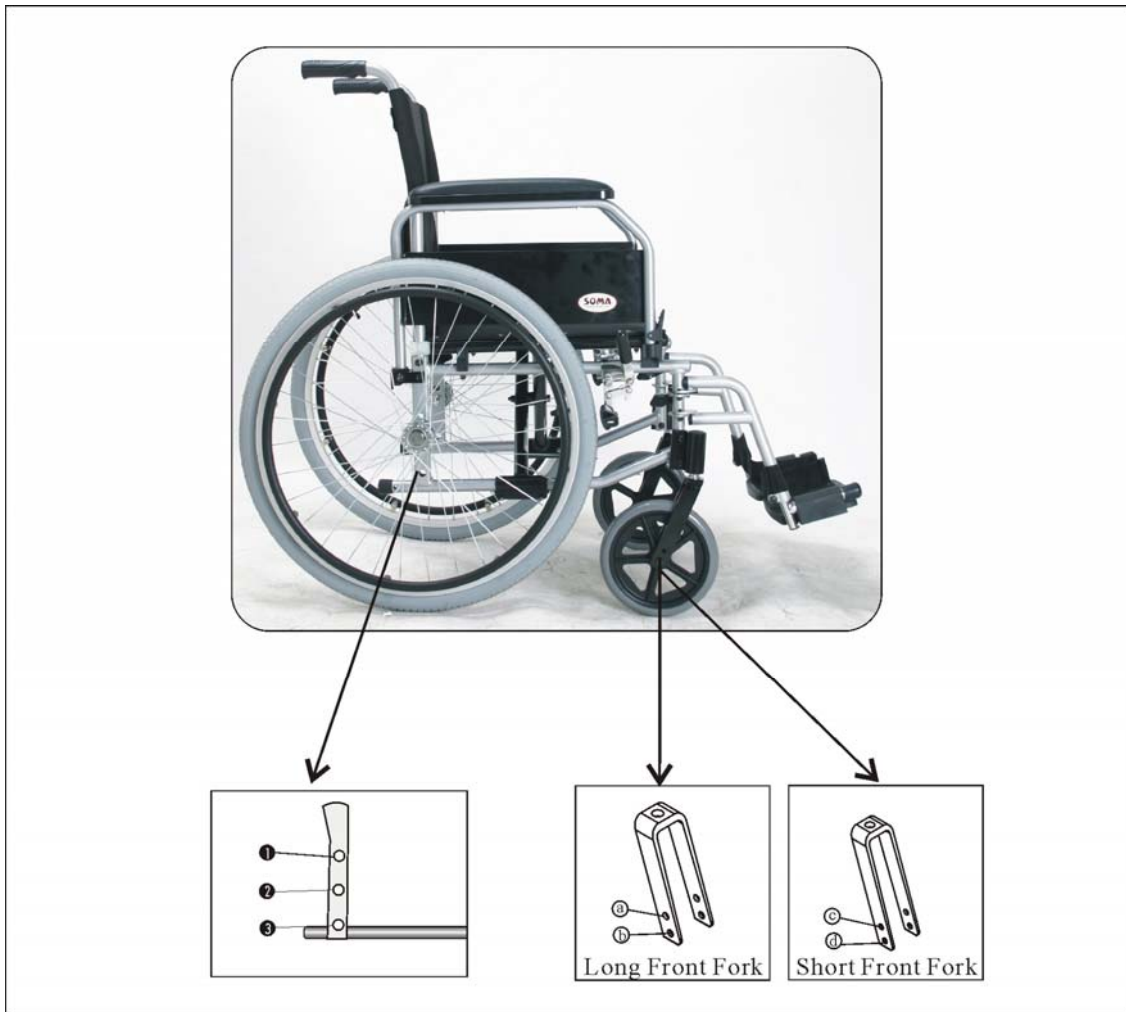





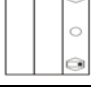
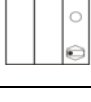
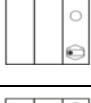



Figure 4.20



CAUTION:

When you change wheel position (whether rear wheels or casters) the center-of-gravity will change simultaneously. We recommend you contact your Karma dealer and therapist, as well as attach anti-tippers.

Front Seat Height (mm)	Front Caster Size (inch)	Front Fork Position	Wheels Size (inch)	Wheel Bar Position	Push Handle Height	Seat Angle	Caster Fork Bolt Direction	Caster Angle
495	8"	b	24"	2	940	4°		90°
475	8"	a	24"	1	910	4°		90°
475	8"	a	16"	3	900	4°		91°
469	6"	b	16"	3	900	3°		89°
450	6"	d	22"	1	880	4°		90°
428	6"	c	22"	1	890	1°		91°
438	6"	d	20"	2	895	4°		90°
430	6"	c	20"	1	860	4°		90°
445	6"	d	16"	3	910	1°		91°

Caster Angle

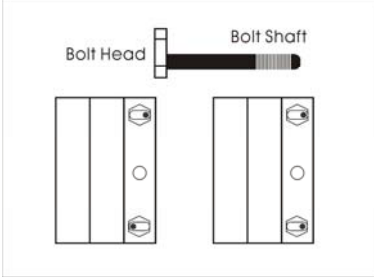
<p>According to different position of caster fork and direction of bolt, caster angles can be adjusted.</p>	 <p style="text-align: center;">Figure 4.21</p>
---	---

4.1.4 Storing

Make sure the wheelchair is folded when stored.



SUGGESTION:

Please store the wheelchair in a location where it is out of direct sunlight, rain and dew. For more details, consult your Karma dealer.



WARNING:

Don't put anything on the wheelchair while it is in storage. Storing goods on a folded or unfolded wheelchair will cause damage and is not covered under warranty. (See Right Figure)



4.2 Transferring In and Out

4.2.1 Transferring In

- Engage both hand brakes.
- Turn the footplates up and swing them to the side.
- The user lowers himself/herself into the seat using the armrests for support.
- Turn the footplates back down, so that the user can place his feet on them. Ensure that the heels rest against the heel supports to prevent contact with the casters.
- Release both hand brakes.



CAUTION:

Always ensure that the front casters are in line with the rear wheels and pointing forwards and that the back of the chair is secure either against a wall or firmly held by an attendant.

4.2.2 Transferring Out

- Make sure that the chair is near your final destination.
- Back the chair sufficiently to ensure that the casters are pointing forward, i.e. in line with the rear wheels and usually with the caster forks pointing forward. Ensure that, where possible, the rear of the chair is against a wall or, if not, it must be firmly held by an attendant.
- Engage both hand brakes.
- Turn up the footplates and swing them to the side.
- Slide forwards on the seat.
- Place one foot firmly on the ground with the knee at a right angle and the other foot slightly apart and further back.
- Place your hands on the front of the armrests and moving your weight forward, bring your head and shoulders up over your knees as you push yourself up.

**CAUTION:**

- Never stand on the footplates when getting into (or out of) the chair. (See Figure 4.22)
- When getting in and out of the wheelchair please use the hand brake. The hand brake is the lever at the side of the wheelchair.
- Please ensure that neither the tread on your tires nor the brake block has become too worn. If pneumatic tires are fitted, please maintain at the recommended tire pressure for the same reason.
- Please ensure that occupant's fingers do not get caught in the brake.

When transferring in and out of the chair, make sure that the brakes are applied to prevent the chair from sliding away. Also see that the footplates are flipped up for ease of entering or exiting. (See Figure 4.23)

4.3 General Use

4.3.1 Attendant Pushing and Self-propelled

- Ensure that the brakes are always locked when the chair is not being pushed. (See Figure 4.24)
- Always make sure that both feet are safely on the footplates and that clothing is safely tucked out of the way and cannot get caught in the wheels. (See Figure 4.25)
- Always use both hands on the push handles to control the chair. (See Figure 4.26)
- Always avoid steep or uneven surfaces because the chair may tip over. (See Figure 4.27)
- Always avoid soft surfaces because the casters may get bogged down. (See Figure 4.28)
- Always be careful not to go too fast or turn too quickly and try to achieve a smooth steady ride.
- Before crossing the tracks, please stop completely and look both ways.
- Cross the tracks perpendicular to avoid your wheels getting stuck.
- Do not drive at full speed over railroad tracks.
- Be careful going through a doorway that your hands and arms do not get injured.

PLEASE keep in contact with the person in the chair. If you stop to look in shop windows or talk to people, remember to turn the chair so that the person in the chair does not have to turn.

**WARNING:**

Never lock the brakes too suddenly as this may tip the user out of the chair.



Figure 4.22



Figure 4.23



Figure 4.24



Figure 4.25



Figure 4.26



Figure 4.27



Figure 4.28



Figure 4.29

4.3.2 Tilting by the Attendant

- Make sure both the user's feet are on the footplates and will not slip off. Make sure the handgrips are secure and cannot slip off.
- Release both brakes.
- Grasp both push handles firmly.
- Put your stronger foot on the relevant tipping lever at the back of the chair.
- Tell the person in the chair that you are about to tilt the chair backwards.
- Pull back with both hands and push down and forwards with the foot. This will bring the chair onto the back wheels. (See Figure 4.29)

CAUTION:

- When a chair is tilted to about 25 degrees it will balance on its rear wheels and be easy to hold. If it is tilted further back it will be difficult to hold and the person in the chair will feel unsafe.
- Lower with a straight back; keep your foot on the anti-tipper and lower the chair slowly forwards softly to the ground.

4.3.3 Tilting by the User

- Make sure your feet are on the footplates and will not slip off.
- Release both brakes.
- Grasp both push rims and give a firm, sudden forward push immediately before the obstacle, continue the momentum (be ready to keep pushing) until the obstacle is mounted.



CAUTION:

- This method should only be attempted by people experienced in wheelchair use. Strong arms are also necessary. It is always better to have the help of an attendant.
- Leaning backwards causes the casters to rise higher BUT it is much safer to lean forwards and stay balanced.

4.3.4 Going Down Kerbs

Please note: It is always better to avoid kerbs where possible by using ramped kerbs or slopes and this operation is best attempted with the aid of an attendant.

4.3.4.1 Going Down kerbs Forwards With an Attendant



CAUTION:

- This is the more difficult method and can jar the user but allows a better view of traffic.
- Be careful that the anti-tipper does not get caught on the kerb causing the user to fall.

NEVER ALLOW THE CHAIR TO TIP FORWARDS WHEN GOING DOWN A CURB.

- Position the chair so that the front casters are near the edge of the kerb and make sure that the road is clear.
- Move the chair slowly and carefully forwards while tilting it back slightly. Be ready to take the weight when the rear wheels cross the kerb edge. Ensure that both rear wheels touch the ground at the same time to avoid tipping the chair.
- Gently lower the front casters. AVOID JARRING THE USER.

4.3.4.2 Going Down Kerbs Backwards With an Attendant



CAUTION:

This is the easier and smoother method BUT it requires the attendant to step backwards into the road.

- Back the chair to the kerb edge and be careful that the back wheels are equally near the edge.
- Grasping the push handles, gently lower the rear wheels onto the road. Be prepared to control the weight as it descends and ensure that the back wheels touch ground at the same time.
- Tilt the chair back slightly and pull the tilted chair far enough into the road so that the

casters and footrests can be lowered clear of the curb.

Going Up Curbs

Please note: This operation is best attempted with the aid of an attendant and the best method is to go up kerbs forwards as this maintains the direction of travel and is physically less demanding for the attendant.

4.3.5.1 Going Up Kerbs Forwards With an Attendant

- As the footrests nearly touch the curb tilt the chair. The chair should be tilted just high enough to allow the front casters to roll smoothly onto the pavement.
- Push the chair forward until the rear wheels are touching the curb. Then, continuing the movement, lift at the push handles while moving the chair forwards.

4.3.5.2 Going Up Kerbs Backwards With an Attendant

Please note: for safety's sake we do not recommend using this method.

4.3.6 Up and Down Steps/Stairs

Please note: avoid flights of steps particularly if no extra help is available. Use ramps or lifts wherever possible.

Two attendants are necessary, each capable of carrying at least half of the combined weight of the person and the wheelchair.

Each helper should bend at the knees and grip the main frame: with the front attendants hands just under the front of the seat, with the back attendant's hands holding the frame just under the push handles.



CAUTION:

Don't attempt to lift the wheelchair by any removable (detachable) parts. Lifting by means of any removable (detachable) parts of wheelchair may result in injury to the user and/or assistant or damage to the wheelchair.

ALL LIFTING SHOULD BE DONE WITH A STRAIGHT BACK.

Straighten legs to lift the chair. Carefully carry it up or down steps; be aware of how you place your feet -- do not cross them and trip yourself up.

5. INSPECTION AND MAINTENANCE

5.1 Daily Check

Check the following items before traveling. If you find anything abnormal, visit your Karma wheelchair dealer for further inspection before using it.

- Examine brakes, checking for wear, damage and misalignment. Replacing or adjusting the brakes should be carried out by your approved repairer.
- Check that the hand grips are not damaged and are securely bonded to the push handles.
- Check anti-tippers are not damaged and are securely attached.
- Check that the anti-tippers' wheels and frame are not damaged and are securely mounted.

- Before using the wheelchair, make sure all nuts and bolts are tight. Check all parts for damage or wear and have a qualified technician replace it if necessary. Check all parts for proper adjustment.
- Inspect brakes for proper operation.
- The wheels and tires should be checked periodically for cracks and wear, and should be replaced by a qualified technician.
- A qualified technician can be found with an authorized distributor/dealer.



CAUTION:

Visit a Karma wheelchair dealer for inspection and maintenance if you find anything abnormal.

5.2 Regular Maintenance Record

To make sure your wheelchair is in good condition, visit your Karma wheelchair dealer regularly for maintenance (and keep records accordingly) every six months after purchasing.

A maintenance/service fee may apply.



SUGGESTION:

Even if you don't use the vehicle for a long time, the wheelchair should still be maintained regularly. You should clean your wheelchair regularly to keep it beautiful and safe.

Item	Weekly	Monthly
GENERAL		
● Wheelchair rolls straight (no excessive drag or pull to one side)		V
FRAME AND CROSS BARS		
● Inspect frame structure for small cracks/fissures		V
● Inspect for bent frame or cross bars		V
BRAKES		
● Do not interfere with tires when rolling		V
● Pivot points free of wear and looseness		V
● Easy to engage	V	
● Prevent chair from moving when engaged	V	

SEAT & BACKREST		
<ul style="list-style-type: none"> ● Inspect for rips or sagging ● Inspect for loose or broken hardware 	V	V
CASTERS		
<ul style="list-style-type: none"> ● Inspect the casters for smooth rotation of the caster wheel and caster assembly ● Inspect the caster for wear in the bearings/mountings and for tire wear or damage 		V V
REAR WHEELS		
<ul style="list-style-type: none"> ● If Installed, quick-release axles lock properly; lubricate if necessary ● No excessive side movement or binding when lifted and spun ● Inspect for cracked, bent or broken spokes 	V V	V
ARMRESTS		
<ul style="list-style-type: none"> ● If installed, inspect the detachable armrest button for effective locking ● Make sure the armrest detaches and flips back properly 		V V
FOOTRESTS		
<ul style="list-style-type: none"> ● Inspect the footplate height adjustment screws are securely tightened ● Inspect the swing-away footrest release lever for effective locking 		V V
TIRES		
<ul style="list-style-type: none"> ● Inspect for flat spots, cracks and wear ● If pneumatic tires, check for proper inflation ● Check tire tread depth is more than 1 mm ● Check tire pressure; tire pressures are located on the side of the tire 	V V V	V



CAUTION:

- If you find anything abnormal, stop using the wheelchair immediately and visit a KARMA wheelchair dealer for inspection and maintenance.
- As with any wheelchair, the wheels and tires should be checked periodically for cracks and wear, and should be replaced. Failure to keep tires at the correct pressure will reduce the braking efficiency.
- Never disassemble or modify the wheelchair frame structure. Otherwise, injury or damage may occur. This will negate the warranty.

6. OPTIONS AND ACCESSORIES



- Magnesium Alloy Rear Wheel (MG-40)
 - Sliver spokes + bright yellow tire.
 - Attaches to all Karma manual wheelchairs.



- I.V. Pole Holder
 - Height adjusts from 130cm (51") to 200cm (78").
 - Attaches to all Karma manual wheelchairs.



- Oxygen Tank Holder
 - Standard size attaches to the back of wheelchairs.
 - Attaches to all Karma manual wheelchairs.



- Backrest Bag
 - Standard size.
 - Attaches to all Karma manual wheelchairs.



- Folding Drink Holder
 - Collapses and adjusts to the size of the container (6-10 cm).
 - Attaches to all Karma manual wheelchairs.



- Anti-tippers
 - Attaches to all Karma manual wheelchairs.



- Multi-Purpose Safety Belt
 - Attaches to all Karma manual wheelchairs.

- Headrest
 - Attaches to all Karma manual wheelchairs.

 **CAUTION:**

● Attaching accessories may alter the overall stability and center-of-gravity of the chair. Thus, this should be performed by your approved repairer and therapist.

7. TROUBLESHOOTING

Trouble or Problems with Your Wheelchair

You can inspect the following before taking your wheelchair to a Karma wheelchair dealer. If you cannot solve the problem by yourself, please contact your Karma wheelchair dealer for help.

Problem	Checking Points and Corrective Action
1. Chair Veers Right/Left	<ul style="list-style-type: none"> • Check tires for correct and equal pressure • Check caster bracket angle • Check that rear wheels are equally spaced from the seat frame
2. Sluggish Turn or Performance	<ul style="list-style-type: none"> • Check tires for correct and equal pressure • Check for loose nuts and bolts
3. Caster Flutter/Wobble	<ul style="list-style-type: none"> • Check tires for correct and equal pressure • Check for loose nuts and bolts • Check caster bracket angle
4. Squeaks and Rattles	<ul style="list-style-type: none"> • Check for loose nuts and bolts
5. Looseness in Chair	<ul style="list-style-type: none"> • Check for loose nuts and bolts

8. SPECIFICATIONS

Model	16" x 17"	17"x17"	18" x 17"	20" x 17"
Overall Length (mm)	1110			
Overall Width (mm)	590	615	640	690
Overall Height (mm)	940			
Total Weight (kg)	14.6	14.7	14.8	15.0
Seat Width (mm)	410	435	460	510
Seat Depth (mm)	430			
Seat Height (mm)	480			
Backrest Height (mm)	430			
Armrest Height (mm)	230			
Calf Length (mm)	390-480			
Overall Collapsed Length (mm)	870			
Overall Collapsed Width (mm)	320			
Overall Collapsed Height (mm)	1750			
Maximum User Weight (kg)	115			

Static Stability Test (According to ISO 7176-1:1999)

Forward	Max. 17 degrees
Backward	Max. 15 degrees
Sideways	Max. 10 degrees

- The degree tolerance is +0, -1 degree.
- The test condition: size of test dummy used 115 kg.
- Please don't travel across a slope (in any direction) greater than 7 degrees.

9. CLEANING & RECYCLING

9.1 Cleaning

In order to lengthen the life of your wheelchair, it is suggested that you clean the wheelchair periodically (if not daily), especially after it is used in the rain or snow. We suggest that you don't use your wheelchair in the rain or snow. If you are traveling and get caught in the rain, we suggest you try to find shelter while waiting it out. If you can't find shelter, proceed to your destination.

9.1.1 Frame

Wipe with a damp cloth.

9.1.2 Upholstery

- When cleaning the upholstery, use warm water and a mild soap.
- Upholstery cleaner/foam can also be used, but avoid other cleaning solvents.

9.2 Post-Consumer Recycling

A post-consumer recycling plan should follow the Environmental Protection Administration's regulations. The items listed below are for reference only as local laws and regulations may vary.

Material	Part Name	Method
Aluminum-alloy	Frame	Recyclable
Plastic	Modular Components	Recyclable
Paper	Owner's Manual	Recyclable

- There are many organizations in many countries you can find on the Internet that will accept used goods for charity. Please search the information highway to help less fortunate individuals and protect our planet for future generations. If you do not have access to the world wide web please use your local phone directory, ask for operator assistance or go to your local government center for more information. Earth Day is every day.
- Check with your local recycling center on where and how to recycle your wheelchair as this information varies from region to region.

10. WARRANTY

10.1 Serial Number

To ensure after-sale service and warranty, please record and fill in the serial number which can be found on the frame.

Model	Econ 800 (SM-802.2)
Serial Number	

10.2 Warranty Policy

10.2.1 Contents and Duration of Warranty

- Repair will be provided free of charge if the problems are due to manufacturing or defective components within the warranty period (a repair of this kind will hereafter be called warranty repair).
- Warranty repairs can be performed by authorized Karma wheelchair dealers only.
- Karma is not responsible for the transportation costs for repair and replacement.
- Replaced parts will be the property of Karma.

10.2.2 Items Not Covered by Warranty

- Irregularities that do not affect function and safety of product.
- Damage resulting from normal wear and tear.
- Problems arising due to lack of basic maintenance and self-inspection.
- Damage resulting from use not following operation guidelines.
- Installation or use of parts not manufactured by Karma.
- Installation or use extra power assist drive unit on the wheelchair.
- Damage resulting from use in unsuitable environments.
- Any addition, modification, or alteration not authorized by Karma.
- Damage resulting from external factors such as chemicals, oil, debris, etc.
- Natural disaster.

10.2.3 Karma is Not Responsible for The Following Costs

- Replacement or refill of consumable parts, oil, lubricant.
- Inspection, adjustment, cleaning, etc.
- Karma designated self-inspection costs.

10.2.4 Responsibilities

10.2.4.1 The Responsibilities of the User

- Fully adhere to operation guidelines set forth in this manual.
- Perform self-inspection and basic maintenance.
- Keep a record of self-inspections and basic maintenance.
- Not permit any alteration, addition, or modification or use of parts not manufactured by Karma.
- Thoroughly read and understand this manual.

10.2.4.2 The Responsibilities of the Dealer

- Follow this manual and educate user about product operation and basic maintenance.

- Verify whether or not conditions of warranty have been met.
- Provide relevant warranty information and recommendations for improvements.

10.2.5 Stipulations

Consumables such as tires, front casters, seat cushions, backrest cushions, etc. are not covered by the warranty.

10.2.6 Warranty Duration and Parts Covered by the Warranty

Please contact your local dealer.

10.2.7 Transfer of Warranty Rights

If you purchase a second-hand Karma wheelchair while it is still with in the warranty period, bring this owner's manual and the wheelchair to the dealership where the wheelchair was purchased for registration.

Full Name:	
Gender:	
Date of Birth:	
Address:	
Model:	
Serial Number:	
Date of Purchase:	

Dealer's Data

Name of the Store:	
Phone No. and Address:	

If you have any suggestions on how to improve our products, please don't hesitate contacting your local dealer to let us know what you think of your wheelchair. Thank you and enjoy.

SOMA

National agent:

Sold and serviced by:

KARMA MEDICAL PRODUCTS CO., LTD.

[Http://www.KarmaMedical.com](http://www.KarmaMedical.com)

E-mail:globalsales@karma.com.tw

KARMA reserves the right to modify information herein without further notice.