

**Stealth Products**<sup>®</sup>

Positioning & Support



**USER MANUAL**



## Comfort Plus Series

---

Stealth's User Manual and Maintenance Guide for  
the Comfort Plus Series Headrest

Stealth Products strives for 100% customer satisfaction. Your complete satisfaction is important. Please contact us with feedback or suggested changes that will help improve the quality and usability of our products.

You may reach us at:



Stealth Products, LLC

104 John Kelly Drive, Burnet, TX 78611

Phone: (512) 715-9995

Toll Free: 1(800) 965-9229

Fax: (512) 715-9954

Toll Free: 1(800) 806-1225

info@stealthproducts.com

www.stealthproducts.com



MDSS GmbH

Schiffgraben 41

30175 Hannover, Germany



## General

Read and understand all instructions prior to the use of the product. Failure to adhere to instructions and warnings in this document may result in property damage, injury, or death. Product misuse due to failure of the following instructions will void the warranty.

Immediately discontinue use if any function is compromised, parts are missing, loose, or shows signs of excessive wear. Consult with your supplier for repair, adjustment, or replacement.

## Important Information!

All persons responsible for fitting, adjustment, and daily use of the devices discussed in these instructions must be familiar with and understand all safety aspects of the devices mentioned. In order for our products to be used successfully, you must:

- Read and understand all instructions and warnings.
- Maintain our products according to our instructions on care and maintenance.
- Devices should be installed and adjusted by a trained technician.

## Supplier Reference

Supplier: \_\_\_\_\_

Telephone: \_\_\_\_\_

Address: \_\_\_\_\_

\_\_\_\_\_

Purchase Date: \_\_\_\_\_

Model: \_\_\_\_\_

Before you install or begin using this product, it is important that you read and understand the content of these installation and operating instructions. The installation instructions will guide you through the possibilities with the Comfort Plus Headrest.

Instructions are written with the expressed intent of use with standard configurations. They also contain important safety and maintenance information. For further assistance, or more advanced applications, please contact your supplier or Stealth Products at (512) 715-9995 or toll free at 1-800-965-9229.

Always keep the operating instructions in a safe place so they may be referenced as necessary.

All information, pictures, illustrations, and specifications are based on the product information that was available at the time of printing. Pictures and illustrations shown in these instructions are representative examples and are not intended to be exact depictions of the various parts of the product.

## Ordering Documentation

You can download additional copies of this User Manual on the Stealth website:  
[www.stealthproducts.com/gui/docs/?type=usr&](http://www.stealthproducts.com/gui/docs/?type=usr&)

Or search:

Comfort Plus User Manual in the search bar at the top of the page.

Our products are designed, manufactured, and produced to the highest of standards. If any defect in material or workmanship is found, Stealth Products will repair or replace the product at our discretion. Any implied warranty, including the implied warranties of merchantability and fitness for a particular purpose, shall not extend beyond the duration of this warranty. Stealth Products, LLC does not warrant damage due to, but not limited to:

- Misuse, abuse, or misapplication of products.
- Modification or product without written approval from Stealth Products, LLC.
- Any alteration or lack of serial number, where applicable, will automatically void this warranty.
- Stealth Products, LLC is liable for replacement parts only.
- Stealth Products, LLC is not liable for any incurred labor costs.

No person is authorized to alter, extend, or waive the warranties of Stealth Products, LLC.

Stealth Products warrants against failure due to defective materials or workmanship:

Covers: 180 days

Hardware: 5 years

Electronics: 3 years

## In Case of Product Failure

In the event of product failure covered by our warranty, please follow the procedures outlined below:



1. Call Stealth at +1 (512) 715-9995 or toll free +1-800-965-9229.
2. Request the Returns Department or obtain an RA from the Returns Department and follow department or documentation instructions.

<b>1.0 Customer Satisfaction</b> .....	<b>i</b>
<b>2.0 Important Information</b> .....	<b>ii</b>
<b>3.0 Introduction</b> .....	<b>iii</b>
<b>4.0 Warranty</b> .....	<b>iv</b>
<b>5.0 Table Of Contents</b> .....	<b>v</b>
<b>6.0 Warning Labels</b> .....	<b>vi</b>
6.1 Warning Labels .....	vi
6.2 Limited Liability.....	vi
6.3 Testing.....	vi
<b>7.0 Parts And Accessories</b> .....	<b>1</b>
7.1 Parts Included.....	1
7.2 Available Sizes.....	1
7.3 To Install .....	1
<b>8.0 Mounting Headrest To Hardware</b> .....	<b>2</b>
8.1 Multi Axis Or Link Hardware.....	2
8.2 Multi Axis Hardware.....	2
8.3 Link Hardware .....	3
8.4 Flip Down Hardware .....	3
8.5 Standard Straight Hardware .....	4
<b>9.0 First Time Use</b> .....	<b>5</b>
9.1 Dealer Assistance .....	5
9.2 User Testing .....	5
9.3 Conditions Of Use.....	5
<b>10.0 Maintenance</b> .....	<b>6</b>
10.1 Care And Maintenance.....	6

## Warning Labels

### 6.1

Warnings are included for the safety of the user, client, operator and property. Please read and understand what the signal words **SAFETY**, **NOTICE**, **CAUTION**, **WARNING** and **DANGER** mean, how they could affect the user, those around the user, and property.

 <b>DANGER</b>	Identifies an <b>imminent</b> situation which (if not avoided) will result in <b>severe injury, death, and property damage</b> .
 <b>WARNING</b>	Identifies a <b>potential</b> situation which (if not avoided) will result in <b>severe injury, death, and property damage</b> .
 <b>CAUTION</b>	Identifies a <b>potential</b> situation which (if not avoided) will result in <b>minor to moderate injury, and property damage</b> .
<b>NOTICE</b>	Identifies important information not related to injury, but possible <b>property damage</b> .
<b>SAFETY</b>	Indicates steps or instructions for safe practices, reminders of safe procedures, or important safety equipment that may be necessary.

## Limited Liability

### 6.2

Stealth Products, LLC accepts no liability for personal injury or damage to property that may arise from the failure of the user or other persons to follow the recommendations, warnings, and instructions in this manual.

## Testing

### 6.3

Initial setup and driving should be done in an open area free of obstacles until the user is fully capable of driving safely.

Ensure that the client is properly aligned with the headrest and that their position allows for maximum comfort and proper positioning.

## Parts Included

## 7.1

Each seat back mount will come with the following:

- Two 1/4-20 X 3/4" Socket Head Screws
- Four 10-32 X 3/4" Socket Head Screws for mounting to the seat back

## Available Sizes

## 7.2

Part Number	CP350	CP450	CP250	CP150	CP550
Size	Niño Small	Small	Medium	Large	X-Large
Width	6in.	8in.	10in.	14in.	19in.
Height	4in.	6in.	6in.	6in.	6in.

## To Install

## 7.3

1. Drill the necessary holes in the seat back.
2. Insert the 1/4-20 and/or the 10-32 Socket Head Screws through the designated holes in the seat back mount and through the seat back.
3. Fasten with nuts on the opposite side.

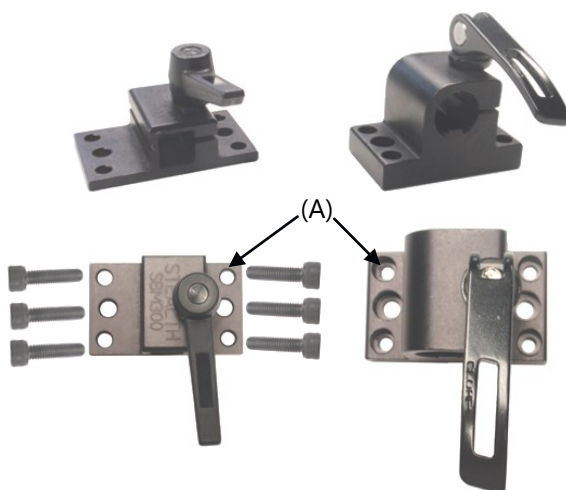



## Multi Axis Or Link Hardware

### 8.1

To install Multi Axis or Link Hardware to the headrest:

1. Place the 1" ball into the designated socket in the rear of the headrest.
2. Place the split ring around the 1" ball.
3. Insert the three socket head screws (B) through the ring and into the threaded holes in the rear of the headrest.
4. Tighten screws with a 5/32 hex key.



## Multi Axis Hardware

### 8.2

There are three points of adjustment on the multi axis hardware:

- Angle
- Fore/aft
- Rotational adjustment

To adjust:

1. Lightly loosen the socket head screws and flat head screw in the triangle (C).
2. Set desired position and retighten screws.

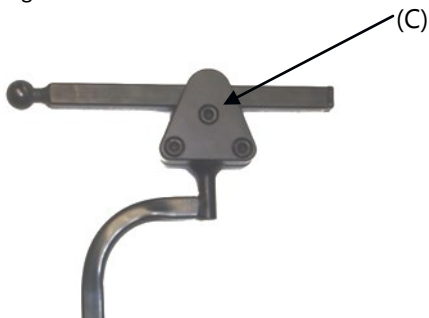

## Link Hardware

## 8.3

There are three points of angle adjustment on the link hardware. To adjust angles (D):

1. Lightly loosen the flat head screws.
2. Set desired angles and retighten screws.

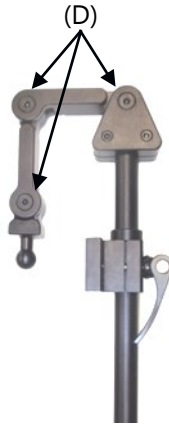

## Flip Down Hardware

## 8.4

To use the flip down function (with link hardware/offset link hardware):

1. Pull down on the red sleeve (E), the hardware will flip down.
2. The hardware will automatically lock into place when returning to the upright position.

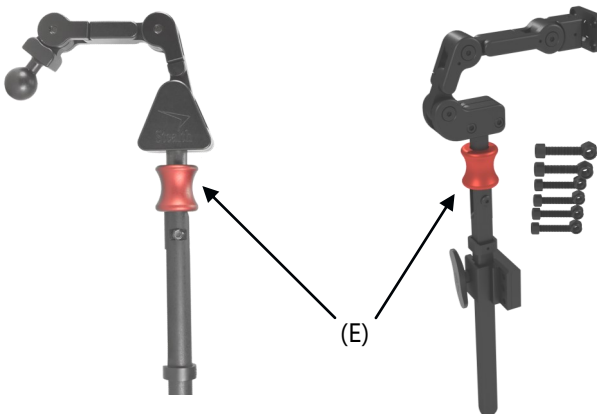

## Standard Straight Hardware

## 8.5

The standard straight hardware\* offers fore/aft adjustment. To adjust:

1. Lightly loosen the socket head screws (F).
2. Set to desired position and retighten screws.

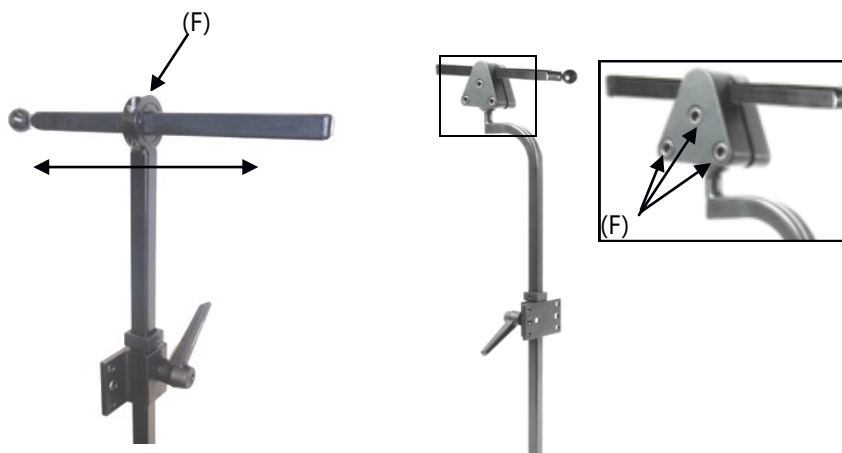

\*HMO400 and HMO475-1 hardware shown

### **NOTICE**

All headrests, aside from their standard adjustability, also offers height adjustment via the seat back mount.

### **WARNING**

During transport, ensure the client is properly aligned and that seat belts and harnesses are fastened.

### **WARNING**

The Comfort Plus Headrest is not intended to be used as a stabilizer during transport.

## Dealer Assistance

### 9.1

During first time use by the client, it is advised that the dealer or service technician assists and explains the configuration to the customer (the user and/or the attendant). If needed, the dealer can make final adjustments.

#### **WARNING**

The Comfort Plus Headrest should only be prescribed and fitted by qualified health care professionals.

## User Testing

### 9.2

It is important that the customer is fully aware of the installation and how the headrest can be adjusted in order to gain the best positioning possible. As a dealer, proceed as follows:

- Explain and show the customer how you have executed the installation, and explain the function.

Have the user test the position of the Comfort Plus Headrest:

- Is the headrest in the proper position for the client?
- Can the user safely operate the chair?
- Is the placement of the Comfort Plus in an optimal position for the user?

If needed, adjust the Comfort Plus to the proper position.

Explain to the customer any possible issues and how to address them.

## Conditions Of Use

### 9.3

The Comfort Plus is intended for use as installed by the dealer, in accordance to the installation instructions in this manual:

- The foreseen conditions of use are communicated by the dealer or service technician to the user and/or attendant during the first time use.
- If the conditions of use change significantly, please contact your dealer or a qualified service technician to avoid excessive wear and tear or unintended damage.

## Care And Maintenance

## 10.1

- Periodically check the hardware for loose screws or worn parts.

### **SAFETY**

Replace or repair parts as needed.

- Check the headrest for any foam breakdown and/or metal coming through the foam. This could be potentially dangerous for the client.
- To wash the headrest cover, remove the cover from the headrest. Machine wash in cold water, delicate cycle, and drip dry.

### **DANGER**

Failure to comply with these warnings could result in serious bodily harm.







Stealth Products, LLC. • [info@stealthproducts.com](mailto:info@stealthproducts.com) • [www.stealthproducts.com](http://www.stealthproducts.com)  
+1(800) 965-9229 | +1(512) 715-9995 | 104 John Kelly Drive, Burnet TX 78611